



HOW TO USE THIS INSTALL GUIDE

- 1** Open the Bookmarks menu and find your vehicle OR scroll down until you find the install guide for your vehicle.
- 2** Print only the pages for your vehicle using the advanced options in the Print menu.
- 3** Install your Maestro RR according to the guide for your vehicle.

WARNING

Pressing the printer icon or “quick printing” this document will print all of the guides in this compilation.



INSTALL GUIDE VOLKSWAGEN BEETLE 2012-2015

RETAINS STEERING WHEEL CONTROLS, MFD, MDI, VW BLUETOOTH AND MORE!



PRODUCTS REQUIRED

iDatalink Maestro RR Radio Replacement Interface
iDatalink Maestro VW1 Installation Harness

OPTIONAL ACCESSORIES

None

PROGRAMMED FIRMWARE

ADS-RR(SR)-VW01-DS

NOTICE: Automotive Data Solutions Inc. (ADS) recommends having this installation performed by a certified technician. Logos and trademarks used here in are the properties of their respective owners.

WELCOME

Congratulations on the purchase of your iDatalink Maestro RR Radio replacement solution. You are now a few simple steps away from enjoying your new car radio with enhanced features.

Before starting your installation, please ensure that your iDatalink Maestro module is programmed with the correct firmware for your vehicle and that you carefully review the install guide.

Please note that Maestro RR will only retain functionalities that were originally available in the vehicle.

NEED HELP?

 **1 866 427-2999**

 support@idatalink.com

 maestro.idatalink.com/support
www.12voltdata.com/forum

TABLE OF CONTENTS

Installation Instructions	3
Wiring Diagram	5
Vehicle Wire Reference Chart	6
Radio Wire Reference Chart	7

INSTALLATION INSTRUCTIONS

STEP 1

- Unbox the aftermarket radio and locate its main harness.
- Connect the wires shown on the next page from aftermarket radio main harness to the VW1 T-harness and match the wire functions.

STEP 2

- Connect the factory harness to the VW1 T-harness.
- Mate the male and female 4 pin WHITE connectors of the VW1 T-harness.
- Do not use any of the RCA plugs (WHITE, GRAY, GREEN & PURPLE) of the VW1 T-harness.

STEP 3

- Access the OBDII connector located under the driver side dashboard.
- Connect the BROWN /RED wire of the VW1 T-harness to the wire located at pin 6 of the OBDII connector. (See the vehicle wire chart reference for wire colors)
- Connect the BROWN /YELLOW wire of the VW1 T-harness to the wire located at pin 14 of the OBDII connector. (See the vehicle wire chart reference for wire colors)
- Do not use the GREEN/WHITE wire.

STEP 4

- Plug the aftermarket radio harnesses into the aftermarket radio.
- Plug the Data cable to the data port of the aftermarket radio.
- Insert the Audio cable into the iDatalink 3.5 mm audio jack of the aftermarket radio.

STEP 5

- Connect all the harnesses to the Maestro RR module then proceed to module setup.

The module is now ready to be used.

Insert the aftermarket radio in the dashboard housing and test all the functionalities.

Reassemble the dashboard carefully.

Note: The OEM backup camera cannot be retained with this solution. It can be retained by using a third party component to composite video converter.

OEM BLUETOOTH SETUP

Only one Bluetooth system can be set for hands free calling. This must be determined before installation. Both the factory and aftermarket systems can be used for Bluetooth audio streaming. If the aftermarket Bluetooth is chosen for hands free calling, the aftermarket microphone must be installed in the vehicle and the factory Bluetooth module must be unplugged. In most vehicles, it is located under the passenger seat. If the vehicle is equipped with Bluetooth but there is no Bluetooth module under the passenger's seat then the Bluetooth system is built into the MDI module. Unplugging the MDI module will disable both factory systems.

2013 Kenwood Radios:

For these radio models, the OEM Bluetooth is turned OFF by default. To turn ON the OEM Bluetooth, insert the key into the ignition and turn it to the ACC position. The Radio will turn on and the setup screen will appear. Scroll to the bottom and select the vehicle set up menu by pressing SET. Go to the option OEM Bluetooth and select ON. Press the return arrow then scroll to the bottom of the page select FINISH.

2014 Kenwood Radios:

For these radio models, the OEM Bluetooth is turned ON by default. To turn OFF the OEM Bluetooth, insert the key into the ignition and turn it to the ACC position. The radio will turn ON and the setup screen will appear. Scroll to the bottom and select the vehicle set up menu by pressing SET. Go to the option OEM Bluetooth and select OFF.

2014 Alpine Radios:

For these radio models, the OEM Bluetooth is turned ON by default. To turn OFF the OEM Bluetooth, insert the key into the ignition and turn it to the ACC position. The radio will turn ON and the main screen will appear. Select the settings button, in the top right corner, then select GENERAL. Select INTEGRATION SETUP then select HANDS FREE CONNECTION. Two options will be available ON or OFF, select OFF.

INSTALLATION INSTRUCTIONS

AIRBAG WARNING LIGHT

If an airbag warning light turns ON after starting the vehicle without having the airbag light plugged in, select Clear Airbag Warning to turn OFF that warning light.

Kenwood Radios:

Main Menu>>Setup>>Sources>>Volkswagen Setup>>Vehicle Features>>Clear Airbag Warning

Alpine Radios:

Settings>>General>>Idatalink Setup>> Maestro Module>>Volkswagen Setup>>Vehicle Features>>Clear Airbag Warning

TROUBLESHOOTING TIPS:

- To reset the module back to its factory settings, turn the key to the OFF position then disconnect all connectors from the module. Press and hold the module's programming button and connect all the connectors back to the module. Wait, the module's LED will flash RED rapidly (this may take up to 10 seconds). Release the programming button. Wait, the LED will turn solid GREEN for 2 seconds.
- For technical assistance call 1-866-427-2999 or e-mail "support@idatalink.com". Visit us at "maestro.idatalink.com/support" and "www.12voldata.com/forum/"

WIRING DIAGRAM

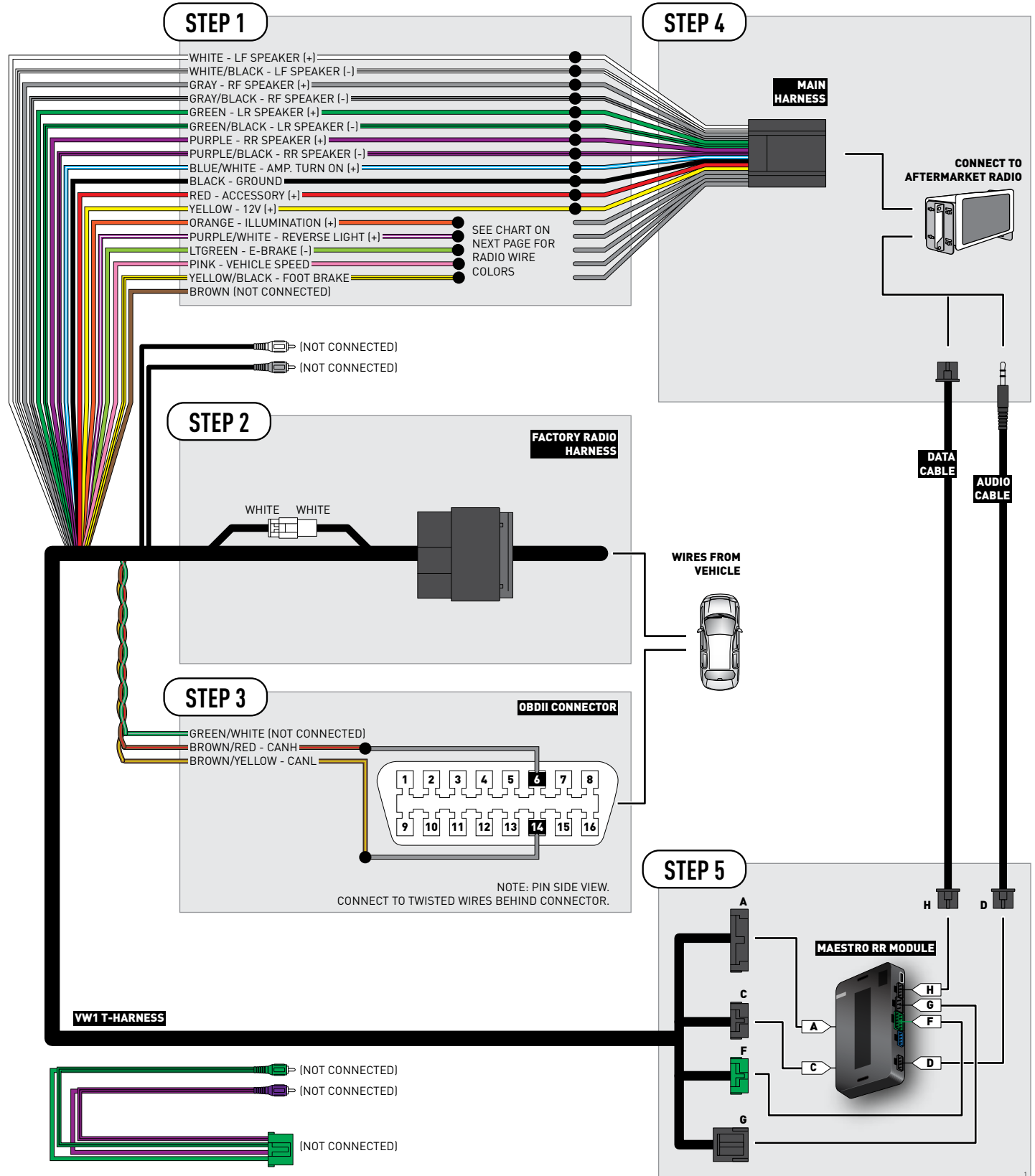

VEHICLE WIRE REFERENCE CHART

Wire Description	Connector Name	Connector Color	Connector Type	Position	Wire Color	Polarity	Wire Location
CanH	A	~	16 pin	06	Orange/Black	(DATA)	OBDII connector, under driver side dash
CanL	A	~	16 pin	14	Orange/Brown	(DATA)	OBDII connector, under driver side dash

RADIO WIRE REFERENCE CHART

Wire Description	Polarity	Wire Color on Maestro T-Harness	Wire Color on Alpine cable	Wire Color on Kenwood cable	Wire Color on Pioneer cable
Illumination	(+)	Orange	N/A	Orange/White	Orange/White
Reverse Light	(+)	Purple/White	Orange/White	Purple/White	Purple/White
E-Brake	(-)	Lt Green	Yellow/Blue	Lt Green	Lt Green
Foot Brake	(+)	Yellow/Black	Yellow/Black	N/A	N/A
VSS (vehicle speed sensor)	(DATA)	Pink	Green/White	N/A	Pink



INSTALL GUIDE VOLKSWAGEN CC 2009-2015

RETAINS STEERING WHEEL CONTROLS, MFD, MDI, VW BLUETOOTH AND MORE!



PRODUCTS REQUIRED

iDatalink Maestro RR Radio Replacement Interface
iDatalink Maestro VW1 Installation Harness

OPTIONAL ACCESSORIES

None

PROGRAMMED FIRMWARE

ADS-RR(SR)-VW01-DS

NOTICE: Automotive Data Solutions Inc. (ADS) recommends having this installation performed by a certified technician. Logos and trademarks used here in are the properties of their respective owners.

WELCOME

Congratulations on the purchase of your iDatalink Maestro RR Radio replacement solution. You are now a few simple steps away from enjoying your new car radio with enhanced features.

Before starting your installation, please ensure that your iDatalink Maestro module is programmed with the correct firmware for your vehicle and that you carefully review the install guide.

Please note that Maestro RR will only retain functionalities that were originally available in the vehicle.

NEED HELP?

 **1 866 427-2999**

 support@idatalink.com

 maestro.idatalink.com/support
www.12voltdata.com/forum

TABLE OF CONTENTS

Installation Instructions	3
Wiring Diagram	5
Vehicle Wire Reference Chart	6
Radio Wire Reference Chart	7

INSTALLATION INSTRUCTIONS

STEP 1

- Unbox the aftermarket radio and locate its main harness.
- Connect the wires shown on the next page from aftermarket radio main harness to the VW1 T-harness and match the wire functions.

STEP 2

- Connect the factory harness to the VW1 T-harness.
- Mate the male and female 4 pin WHITE connectors of the VW1 T-harness.
- Do not use any of the RCA plugs (WHITE, GRAY, GREEN & PURPLE) of the VW1 T-harness.

STEP 3

- Access the OBDII connector located under the driver side dashboard.
- Connect the BROWN /RED wire of the VW1 T-harness to the wire located at pin 6 of the OBDII connector. (See the vehicle wire chart reference for wire colors)
- Connect the BROWN /YELLOW wire of the VW1 T-harness to the wire located at pin 14 of the OBDII connector. (See the vehicle wire chart reference for wire colors)
- Do not use the GREEN/WHITE wire.

STEP 4

- Plug the aftermarket radio harnesses into the aftermarket radio.
- Plug the Data cable to the data port of the aftermarket radio.
- Insert the Audio cable into the iDatalink 3.5 mm audio jack of the aftermarket radio.

STEP 5

- Connect all the harnesses to the Maestro RR module then proceed to module setup.

The module is now ready to be used.

Insert the aftermarket radio in the dashboard housing and test all the functionalities.

Reassemble the dashboard carefully.

Note: The OEM backup camera cannot be retained with this solution. It can be retained by using a third party component to composite video converter.

OEM BLUETOOTH SETUP

Only one Bluetooth system can be set for hands free calling. This must be determined before installation. Both the factory and aftermarket systems can be used for Bluetooth audio streaming. If the aftermarket Bluetooth is chosen for hands free calling, the aftermarket microphone must be installed in the vehicle and the factory Bluetooth module must be unplugged. In most vehicles, it is located under the passenger seat. If the vehicle is equipped with Bluetooth but there is no Bluetooth module under the passenger's seat then the Bluetooth system is built into the MDI module. Unplugging the MDI module will disable both factory systems.

2013 Kenwood Radios:

For these radio models, the OEM Bluetooth is turned OFF by default. To turn ON the OEM Bluetooth, insert the key into the ignition and turn it to the ACC position. The Radio will turn on and the setup screen will appear. Scroll to the bottom and select the vehicle set up menu by pressing SET. Go to the option OEM Bluetooth and select ON. Press the return arrow then scroll to the bottom of the page select FINISH.

2014 Kenwood Radios:

For these radio models, the OEM Bluetooth is turned ON by default. To turn OFF the OEM Bluetooth, insert the key into the ignition and turn it to the ACC position. The radio will turn ON and the setup screen will appear. Scroll to the bottom and select the vehicle set up menu by pressing SET. Go to the option OEM Bluetooth and select OFF.

2014 Alpine Radios:

For these radio models, the OEM Bluetooth is turned ON by default. To turn OFF the OEM Bluetooth, insert the key into the ignition and turn it to the ACC position. The radio will turn ON and the main screen will appear. Select the settings button, in the top right corner, then select GENERAL. Select INTEGRATION SETUP then select HANDS FREE CONNECTION. Two options will be available ON or OFF, select OFF.

INSTALLATION INSTRUCTIONS

AIRBAG WARNING LIGHT

If an airbag warning light turns ON after starting the vehicle without having the airbag light plugged in, select Clear Airbag Warning to turn OFF that warning light.

Kenwood Radios:

Main Menu>>Setup>>Sources>>Volkswagen Setup>>Vehicle Features>>Clear Airbag Warning

Alpine Radios:

Settings>>General>>Idatalink Setup>> Maestro Module>>Volkswagen Setup>>Vehicle Features>>Clear Airbag Warning

TROUBLESHOOTING TIPS:

- To reset the module back to its factory settings, turn the key to the OFF position then disconnect all connectors from the module. Press and hold the module's programming button and connect all the connectors back to the module. Wait, the module's LED will flash RED rapidly (this may take up to 10 seconds). Release the programming button. Wait, the LED will turn solid GREEN for 2 seconds.
- For technical assistance call 1-866-427-2999 or e-mail "support@idatalink.com". Visit us at "maestro.idatalink.com/support" and "www.12voldata.com/forum/"

WIRING DIAGRAM

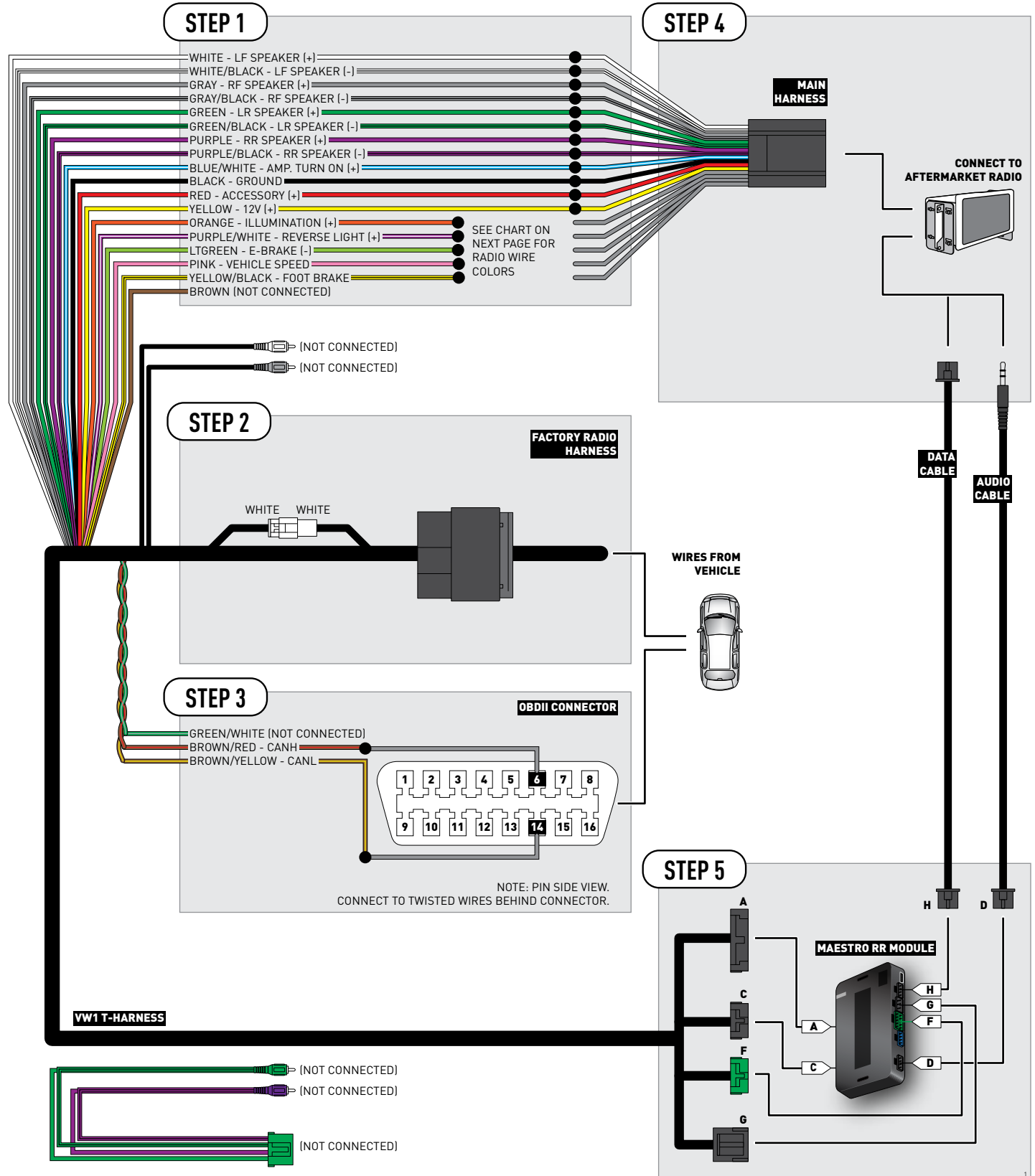

VEHICLE WIRE REFERENCE CHART

Wire Description	Connector Name	Connector Color	Connector Type	Position	Wire Color	Polarity	Wire Location
CanH	A	~	16 pin	06	Orange/Black	(DATA)	OBDII connector, under driver side dash
CanL	A	~	16 pin	14	Orange/Brown	(DATA)	OBDII connector, under driver side dash

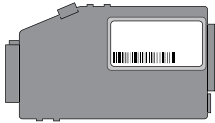

Warning: Factory Compass Module

If your vehicle is equipped with a factory compass module and you are installing an aftermarket radio that supplies navigation information to the MFD of the vehicle, disconnect the factory compass module located under the trunk Lid or in the right rear quarter panel in front and above the tail light.

RADIO WIRE REFERENCE CHART

Wire Description	Polarity	Wire Color on Maestro T-Harness	Wire Color on Alpine cable	Wire Color on Kenwood cable	Wire Color on Pioneer cable
Illumination	(+)	Orange	N/A	Orange/White	Orange/White
Reverse Light	(+)	Purple/White	Orange/White	Purple/White	Purple/White
E-Brake	(-)	Lt Green	Yellow/Blue	Lt Green	Lt Green
Foot Brake	(+)	Yellow/Black	Yellow/Black	N/A	N/A
VSS (vehicle speed sensor)	(DATA)	Pink	Green/White	N/A	Pink



INSTALL GUIDE VOLKSWAGEN EOS 2008-2011

RETAINS STEERING WHEEL CONTROLS, MFD, MDI, VW BLUETOOTH AND MORE!



PRODUCTS REQUIRED

iDatalink Maestro RR Radio Replacement Interface
iDatalink Maestro VW1 Installation Harness

OPTIONAL ACCESSORIES

None

PROGRAMMED FIRMWARE

ADS-RR(SR)-VW01-DS

NOTICE: Automotive Data Solutions Inc. (ADS) recommends having this installation performed by a certified technician. Logos and trademarks used here in are the properties of their respective owners.

WELCOME

Congratulations on the purchase of your iDatalink Maestro RR Radio replacement solution. You are now a few simple steps away from enjoying your new car radio with enhanced features.

Before starting your installation, please ensure that your iDatalink Maestro module is programmed with the correct firmware for your vehicle and that you carefully review the install guide.

Please note that Maestro RR will only retain functionalities that were originally available in the vehicle.

NEED HELP?

 **1 866 427-2999**

 support@idatalink.com

 maestro.idatalink.com/support
www.12voltdata.com/forum

TABLE OF CONTENTS

Installation Instructions	3
Wiring Diagram	5
Vehicle Wire Reference Chart	6
Radio Wire Reference Chart	7

INSTALLATION INSTRUCTIONS

STEP 1

- Unbox the aftermarket radio and locate its main harness.
- Connect the wires shown on the next page from aftermarket radio main harness to the VW1 T-harness and match the wire functions.

STEP 2

- Connect the factory harness to the VW1 T-harness.
- Mate the male and female 4 pin WHITE connectors of the VW1 T-harness.
- Do not use any of the RCA plugs (WHITE, GRAY, GREEN & PURPLE) of the VW1 T-harness.

STEP 3

- Access the OBDII connector located under the driver side dashboard.
- Connect the BROWN /RED wire of the VW1 T-harness to the wire located at pin 6 of the OBDII connector. (See the vehicle wire chart reference for wire colors)
- Connect the BROWN /YELLOW wire of the VW1 T-harness to the wire located at pin 14 of the OBDII connector. (See the vehicle wire chart reference for wire colors)
- Do not use the GREEN/WHITE wire.

STEP 4

- Plug the aftermarket radio harnesses into the aftermarket radio.
- Plug the Data cable to the data port of the aftermarket radio.
- Insert the Audio cable into the iDataLink 3.5 mm audio jack of the aftermarket radio.

STEP 5

- Connect all the harnesses to the Maestro RR module then proceed to module setup.

The module is now ready to be used.

Insert the aftermarket radio in the dashboard housing and test all the functionalities.

Reassemble the dashboard carefully.

Note: The OEM backup camera cannot be retained with this solution. It can be retained by using a third party component to composite video converter.

OEM BLUETOOTH SETUP

Only one Bluetooth system can be set for hands free calling. This must be determined before installation. Both the factory and aftermarket systems can be used for Bluetooth audio streaming. If the aftermarket Bluetooth is chosen for hands free calling, the aftermarket microphone must be installed in the vehicle and the factory Bluetooth module must be unplugged. In most vehicles, it is located under the passenger seat. If the vehicle is equipped with Bluetooth but there is no Bluetooth module under the passenger's seat then the Bluetooth system is built into the MDI module. Unplugging the MDI module will disable both factory systems.

2013 Kenwood Radios:

For these radio models, the OEM Bluetooth is turned OFF by default. To turn ON the OEM Bluetooth, insert the key into the ignition and turn it to the ACC position. The Radio will turn on and the setup screen will appear. Scroll to the bottom and select the vehicle set up menu by pressing SET. Go to the option OEM Bluetooth and select ON. Press the return arrow then scroll to the bottom of the page select FINISH.

2014 Kenwood Radios:

For these radio models, the OEM Bluetooth is turned ON by default. To turn OFF the OEM Bluetooth, insert the key into the ignition and turn it to the ACC position. The radio will turn ON and the setup screen will appear. Scroll to the bottom and select the vehicle set up menu by pressing SET. Go to the option OEM Bluetooth and select OFF.

2014 Alpine Radios:

For these radio models, the OEM Bluetooth is turned ON by default. To turn OFF the OEM Bluetooth, insert the key into the ignition and turn it to the ACC position. The radio will turn ON and the main screen will appear. Select the settings button, in the top right corner, then select GENERAL. Select INTEGRATION SETUP then select HANDS FREE CONNECTION. Two options will be available ON or OFF, select OFF.

INSTALLATION INSTRUCTIONS

AIRBAG WARNING LIGHT

If an airbag warning light turns ON after starting the vehicle without having the airbag light plugged in, select Clear Airbag Warning to turn OFF that warning light.

Kenwood Radios:

Main Menu>>Setup>>Sources>>Volkswagen Setup>>Vehicle Features>>Clear Airbag Warning

Alpine Radios:

Settings>>General>>Idatalink Setup>> Maestro Module>>Volkswagen Setup>>Vehicle Features>>Clear Airbag Warning

TROUBLESHOOTING TIPS:

- To reset the module back to its factory settings, turn the key to the OFF position then disconnect all connectors from the module. Press and hold the module's programming button and connect all the connectors back to the module. Wait, the module's LED will flash RED rapidly (this may take up to 10 seconds). Release the programming button. Wait, the LED will turn solid GREEN for 2 seconds.
- For technical assistance call 1-866-427-2999 or e-mail "support@idatalink.com". Visit us at "maestro.idatalink.com/support" and "www.12voltdata.com/forum/"

WIRING DIAGRAM

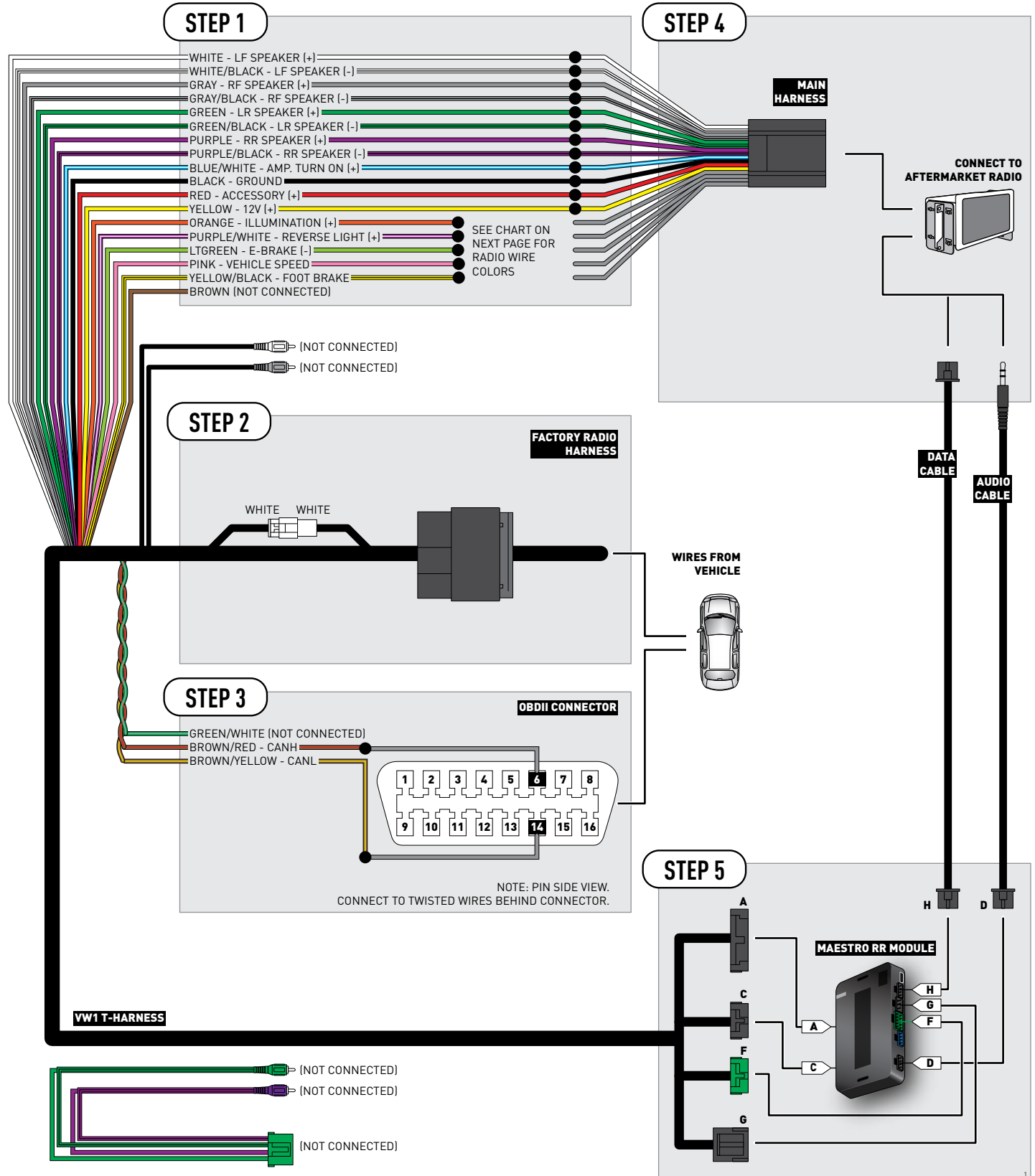

VEHICLE WIRE REFERENCE CHART

Wire Description	Connector Name	Connector Color	Connector Type	Position	Wire Color	Polarity	Wire Location
CanH	A	~	16 pin	06	Orange/Black	[DATA]	OBDII connector, under driver side dash
CanL	A	~	16 pin	14	Orange/Brown	[DATA]	OBDII connector, under driver side dash

RADIO WIRE REFERENCE CHART

Wire Description	Polarity	Wire Color on Maestro T-Harness	Wire Color on Alpine cable	Wire Color on Kenwood cable	Wire Color on Pioneer cable
Illumination	(+)	Orange	N/A	Orange/White	Orange/White
Reverse Light	(+)	Purple/White	Orange/White	Purple/White	Purple/White
E-Brake	(-)	Lt Green	Yellow/Blue	Lt Green	Lt Green
Foot Brake	(+)	Yellow/Black	Yellow/Black	N/A	N/A
VSS (vehicle speed sensor)	(DATA)	Pink	Green/White	N/A	Pink



INSTALL GUIDE VOLKSWAGEN EOS 2012-2016

RETAINS STEERING WHEEL CONTROLS, MFD, MDI, VW BLUETOOTH AND MORE!



PRODUCTS REQUIRED

iDatalink Maestro RR Radio Replacement Interface
iDatalink Maestro VW1 Installation Harness

OPTIONAL ACCESSORIES

None

PROGRAMMED FIRMWARE

ADS-RR(SR)-VW01-DS

NOTICE: Automotive Data Solutions Inc. (ADS) recommends having this installation performed by a certified technician. Logos and trademarks used here in are the properties of their respective owners.

WELCOME

Congratulations on the purchase of your iDatalink Maestro RR Radio replacement solution. You are now a few simple steps away from enjoying your new car radio with enhanced features.

Before starting your installation, please ensure that your iDatalink Maestro module is programmed with the correct firmware for your vehicle and that you carefully review the install guide.

Please note that Maestro RR will only retain functionalities that were originally available in the vehicle.

NEED HELP?

 **1 866 427-2999**

 **support@idatalink.com**

 **maestro.idatalink.com/support**
www.12voltdata.com/forum

TABLE OF CONTENTS

Installation Instructions	3
Wiring Diagram	5
Vehicle Wire Reference Chart	6
Radio Wire Reference Chart	7

INSTALLATION INSTRUCTIONS

STEP 1

- Unbox the aftermarket radio and locate its main harness.
- Connect the wires shown on the next page from aftermarket radio main harness to the VW1 T-harness and match the wire functions.

STEP 2

- Connect the factory harness to the VW1 T-harness.
- Mate the male and female 4 pin WHITE connectors of the VW1 T-harness.
- Do not use any of the RCA plugs (WHITE, GRAY, GREEN & PURPLE) of the VW1 T-harness.

STEP 3

- Access the OBDII connector located under the driver side dashboard.
- Connect the BROWN /RED wire of the VW1 T-harness to the wire located at pin 6 of the OBDII connector. (See the vehicle wire chart reference for wire colors)
- Connect the BROWN /YELLOW wire of the VW1 T-harness to the wire located at pin 14 of the OBDII connector. (See the vehicle wire chart reference for wire colors)
- Do not use the GREEN/WHITE wire.

STEP 4

- Plug the aftermarket radio harnesses into the aftermarket radio.
- Plug the Data cable to the data port of the aftermarket radio.
- Insert the Audio cable into the iDatalink 3.5 mm audio jack of the aftermarket radio.

STEP 5

- Connect all the harnesses to the Maestro RR module then proceed to module setup.

The module is now ready to be used.

Insert the aftermarket radio in the dashboard housing and test all the functionalities.

Reassemble the dashboard carefully.

Note: The OEM backup camera cannot be retained with this solution. It can be retained by using a third party component to composite video converter.

OEM BLUETOOTH SETUP

Only one Bluetooth system can be set for hands free calling. This must be determined before installation. Both the factory and aftermarket systems can be used for Bluetooth audio streaming. If the aftermarket Bluetooth is chosen for hands free calling, the aftermarket microphone must be installed in the vehicle and the factory Bluetooth module must be unplugged. In most vehicles, it is located under the passenger seat. If the vehicle is equipped with Bluetooth but there is no Bluetooth module under the passenger's seat then the Bluetooth system is built into the MDI module. Unplugging the MDI module will disable both factory systems.

2013 Kenwood Radios:

For these radio models, the OEM Bluetooth is turned OFF by default. To turn ON the OEM Bluetooth, insert the key into the ignition and turn it to the ACC position. The Radio will turn on and the setup screen will appear. Scroll to the bottom and select the vehicle set up menu by pressing SET. Go to the option OEM Bluetooth and select ON. Press the return arrow then scroll to the bottom of the page select FINISH.

2014 Kenwood Radios:

For these radio models, the OEM Bluetooth is turned ON by default. To turn OFF the OEM Bluetooth, insert the key into the ignition and turn it to the ACC position. The radio will turn ON and the setup screen will appear. Scroll to the bottom and select the vehicle set up menu by pressing SET. Go to the option OEM Bluetooth and select OFF.

2014 Alpine Radios:

For these radio models, the OEM Bluetooth is turned ON by default. To turn OFF the OEM Bluetooth, insert the key into the ignition and turn it to the ACC position. The radio will turn ON and the main screen will appear. Select the settings button, in the top right corner, then select GENERAL. Select INTEGRATION SETUP then select HANDS FREE CONNECTION. Two options will be available ON or OFF, select OFF.

INSTALLATION INSTRUCTIONS

AIRBAG WARNING LIGHT

If an airbag warning light turns ON after starting the vehicle without having the airbag light plugged in, select Clear Airbag Warning to turn OFF that warning light.

Kenwood Radios:

Main Menu>>Setup>>Sources>>Volkswagen Setup>>Vehicle Features>>Clear Airbag Warning

Alpine Radios:

Settings>>General>>Idatalink Setup>> Maestro Module>>Volkswagen Setup>>Vehicle Features>>Clear Airbag Warning

TROUBLESHOOTING TIPS:

- To reset the module back to its factory settings, turn the key to the OFF position then disconnect all connectors from the module. Press and hold the module's programming button and connect all the connectors back to the module. Wait, the module's LED will flash RED rapidly (this may take up to 10 seconds). Release the programming button. Wait, the LED will turn solid GREEN for 2 seconds.
- For technical assistance call 1-866-427-2999 or e-mail "support@idatalink.com". Visit us at "maestro.idatalink.com/support" and "www.12voltdata.com/forum/"

WIRING DIAGRAM

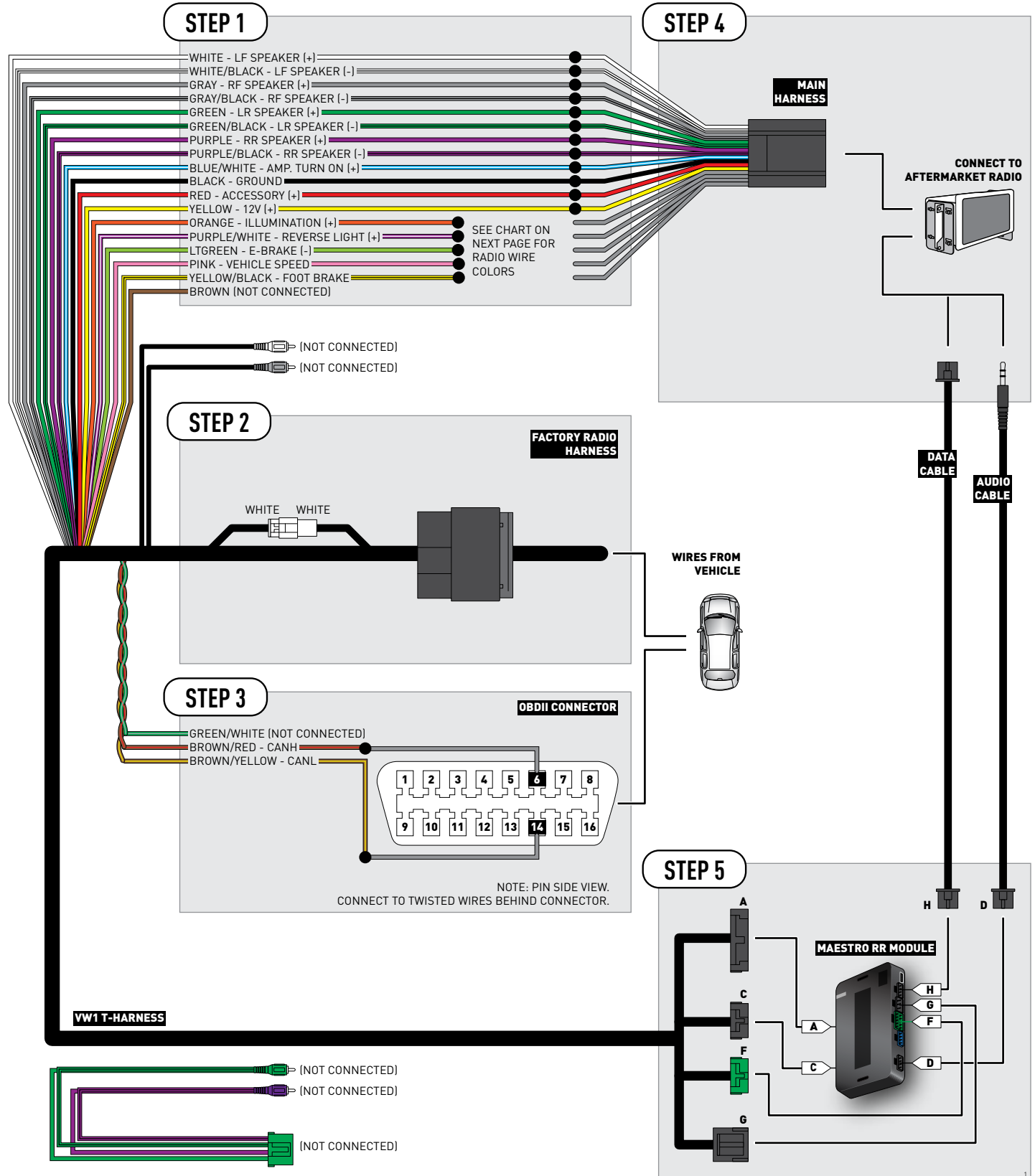

VEHICLE WIRE REFERENCE CHART

Wire Description	Connector Name	Connector Color	Connector Type	Position	Wire Color	Polarity	Wire Location
CanH	A	~	16 pin	06	Orange/Black	(DATA)	OBDII connector, under driver side dash
CanL	A	~	16 pin	14	Orange/Brown	(DATA)	OBDII connector, under driver side dash

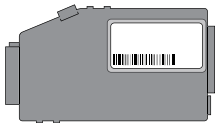

Warning: Factory Compass Module

If your vehicle is equipped with a factory compass module and you are installing an aftermarket radio that supplies navigation information to the MFD of the vehicle, disconnect the factory compass module located under the trunk Lid.

RADIO WIRE REFERENCE CHART

Wire Description	Polarity	Wire Color on Maestro T-Harness	Wire Color on Alpine cable	Wire Color on Kenwood cable	Wire Color on Pioneer cable
Illumination	(+)	Orange	N/A	Orange/White	Orange/White
Reverse Light	(+)	Purple/White	Orange/White	Purple/White	Purple/White
E-Brake	(-)	Lt Green	Yellow/Blue	Lt Green	Lt Green
Foot Brake	(+)	Yellow/Black	Yellow/Black	N/A	N/A
VSS (vehicle speed sensor)	(DATA)	Pink	Green/White	N/A	Pink



INSTALL GUIDE VOLKSWAGEN GOLF 2010-2014

RETAINS STEERING WHEEL CONTROLS, MFD, MDI, VW BLUETOOTH AND MORE!



PRODUCTS REQUIRED

iDatalink Maestro RR Radio Replacement Interface
iDatalink Maestro VW1 Installation Harness

OPTIONAL ACCESSORIES

None

PROGRAMMED FIRMWARE

ADS-RR(SR)-VW01-DS

NOTICE: Automotive Data Solutions Inc. (ADS) recommends having this installation performed by a certified technician. Logos and trademarks used here in are the properties of their respective owners.

WELCOME

Congratulations on the purchase of your iDatalink Maestro RR Radio replacement solution. You are now a few simple steps away from enjoying your new car radio with enhanced features.

Before starting your installation, please ensure that your iDatalink Maestro module is programmed with the correct firmware for your vehicle and that you carefully review the install guide.

Please note that Maestro RR will only retain functionalities that were originally available in the vehicle.

NEED HELP?

 **1 866 427-2999**

 support@idatalink.com

 maestro.idatalink.com/support
www.12voltdata.com/forum

TABLE OF CONTENTS

Installation Instructions	3
Wiring Diagram	5
Vehicle Wire Reference Chart	6
Radio Wire Reference Chart	7

INSTALLATION INSTRUCTIONS

STEP 1

- Unbox the aftermarket radio and locate its main harness.
- Connect the wires shown on the next page from aftermarket radio main harness to the VW1 T-harness and match the wire functions.

STEP 2

- Connect the factory harness to the VW1 T-harness.
- Mate the male and female 4 pin WHITE connectors of the VW1 T-harness.
- Do not use any of the RCA plugs (WHITE, GRAY, GREEN & PURPLE) of the VW1 T-harness.

STEP 3

- Access the OBDII connector located under the driver side dashboard.
- Connect the BROWN /RED wire of the VW1 T-harness to the wire located at pin 6 of the OBDII connector. (See the vehicle wire chart reference for wire colors)
- Connect the BROWN /YELLOW wire of the VW1 T-harness to the wire located at pin 14 of the OBDII connector. (See the vehicle wire chart reference for wire colors)
- Do not use the GREEN/WHITE wire.

STEP 4

- Plug the aftermarket radio harnesses into the aftermarket radio.
- Plug the Data cable to the data port of the aftermarket radio.
- Insert the Audio cable into the iDatalink 3.5 mm audio jack of the aftermarket radio.

STEP 5

- Connect all the harnesses to the Maestro RR module then proceed to module setup.

The module is now ready to be used.

Insert the aftermarket radio in the dashboard housing and test all the functionalities.

Reassemble the dashboard carefully.

Note: The OEM backup camera cannot be retained with this solution. It can be retained by using a third party component to composite video converter.

OEM BLUETOOTH SETUP

Only one Bluetooth system can be set for hands free calling. This must be determined before installation. Both the factory and aftermarket systems can be used for Bluetooth audio streaming. If the aftermarket Bluetooth is chosen for hands free calling, the aftermarket microphone must be installed in the vehicle and the factory Bluetooth module must be unplugged. In most vehicles, it is located under the passenger seat. If the vehicle is equipped with Bluetooth but there is no Bluetooth module under the passenger's seat then the Bluetooth system is built into the MDI module. Unplugging the MDI module will disable both factory systems.

2013 Kenwood Radios:

For these radio models, the OEM Bluetooth is turned OFF by default. To turn ON the OEM Bluetooth, insert the key into the ignition and turn it to the ACC position. The Radio will turn on and the setup screen will appear. Scroll to the bottom and select the vehicle set up menu by pressing SET. Go to the option OEM Bluetooth and select ON. Press the return arrow then scroll to the bottom of the page select FINISH.

2014 Kenwood Radios:

For these radio models, the OEM Bluetooth is turned ON by default. To turn OFF the OEM Bluetooth, insert the key into the ignition and turn it to the ACC position. The radio will turn ON and the setup screen will appear. Scroll to the bottom and select the vehicle set up menu by pressing SET. Go to the option OEM Bluetooth and select OFF.

2014 Alpine Radios:

For these radio models, the OEM Bluetooth is turned ON by default. To turn OFF the OEM Bluetooth, insert the key into the ignition and turn it to the ACC position. The radio will turn ON and the main screen will appear. Select the settings button, in the top right corner, then select GENERAL. Select INTEGRATION SETUP then select HANDS FREE CONNECTION. Two options will be available ON or OFF, select OFF.

INSTALLATION INSTRUCTIONS

AIRBAG WARNING LIGHT

If an airbag warning light turns ON after starting the vehicle without having the airbag light plugged in, select Clear Airbag Warning to turn OFF that warning light.

Kenwood Radios:

Main Menu>>Setup>>Sources>>Volkswagen Setup>>Vehicle Features>>Clear Airbag Warning

Alpine Radios:

Settings>>General>>Idatalink Setup>> Maestro Module>>Volkswagen Setup>>Vehicle Features>>Clear Airbag Warning

TROUBLESHOOTING TIPS:

- To reset the module back to its factory settings, turn the key to the OFF position then disconnect all connectors from the module. Press and hold the module's programming button and connect all the connectors back to the module. Wait, the module's LED will flash RED rapidly (this may take up to 10 seconds). Release the programming button. Wait, the LED will turn solid GREEN for 2 seconds.
- For technical assistance call 1-866-427-2999 or e-mail "support@idatalink.com". Visit us at "maestro.idatalink.com/support" and "www.12voltdata.com/forum/"

WIRING DIAGRAM

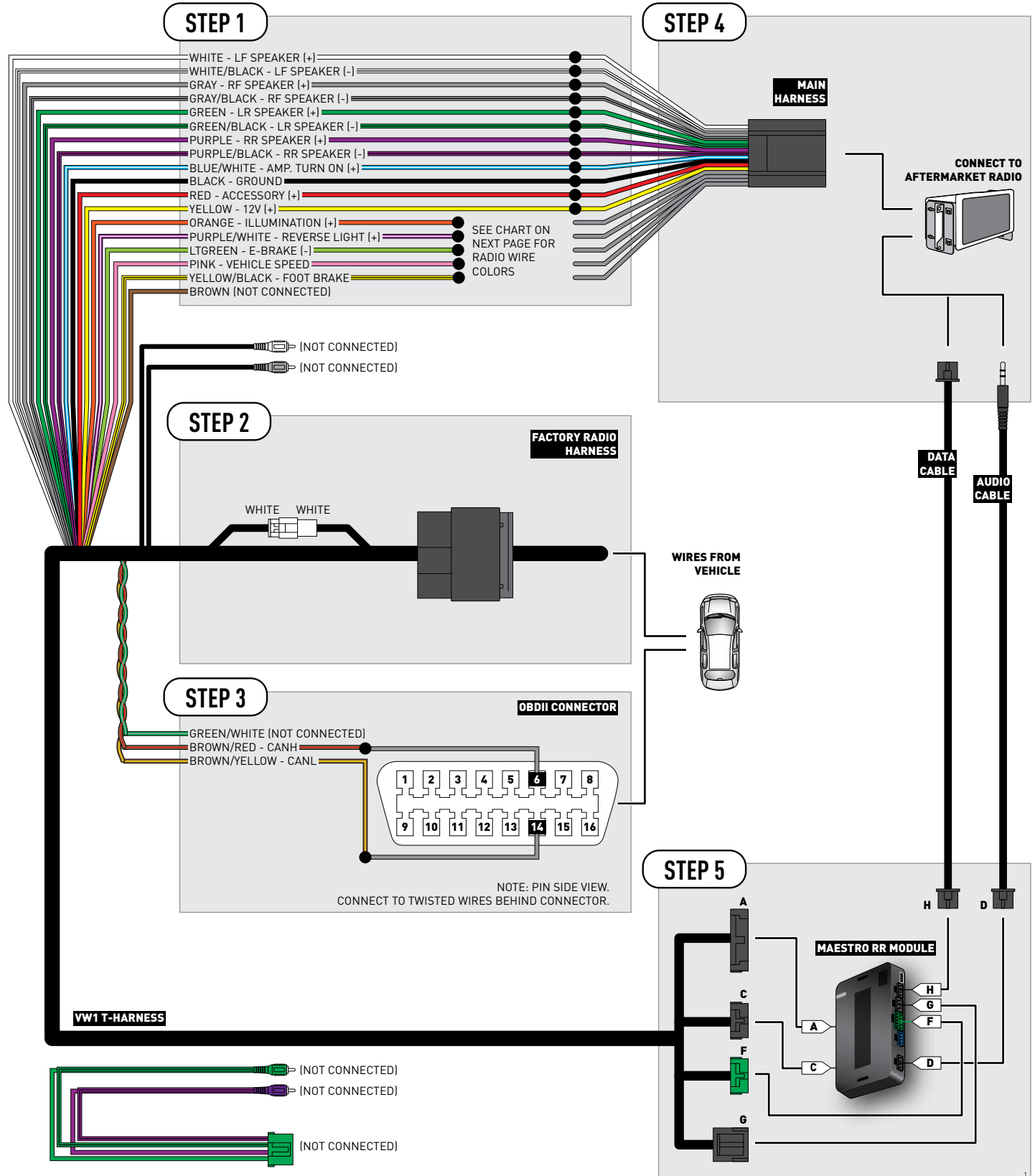

VEHICLE WIRE REFERENCE CHART

Wire Description	Connector Name	Connector Color	Connector Type	Position	Wire Color	Polarity	Wire Location
CanH	A	~	16 pin	06	Orange/Black	(DATA)	OBDII connector, under driver side dash
CanL	A	~	16 pin	14	Orange/Brown	(DATA)	OBDII connector, under driver side dash

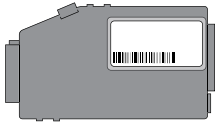

Warning: Factory Compass Module

If your vehicle is equipped with a factory compass module and you are installing an aftermarket radio that supplies navigation information to the MFD of the vehicle, disconnect the factory compass module located under the headliner at the rear of the vehicle.

RADIO WIRE REFERENCE CHART

Wire Description	Polarity	Wire Color on Maestro T-Harness	Wire Color on Alpine cable	Wire Color on Kenwood cable	Wire Color on Pioneer cable
Illumination	(+)	Orange	N/A	Orange/White	Orange/White
Reverse Light	(+)	Purple/White	Orange/White	Purple/White	Purple/White
E-Brake	(-)	Lt Green	Yellow/Blue	Lt Green	Lt Green
Foot Brake	(+)	Yellow/Black	Yellow/Black	N/A	N/A
VSS (vehicle speed sensor)	(DATA)	Pink	Green/White	N/A	Pink



INSTALL GUIDE VOLKSWAGEN GOLF R 2012-2013

RETAINS STEERING WHEEL CONTROLS, MFD, MDI, VW BLUETOOTH AND MORE!



PRODUCTS REQUIRED

iDatalink Maestro RR Radio Replacement Interface
iDatalink Maestro VW1 Installation Harness

OPTIONAL ACCESSORIES

None

PROGRAMMED FIRMWARE

ADS-RR(SR)-VW01-DS

NOTICE: Automotive Data Solutions Inc. (ADS) recommends having this installation performed by a certified technician. Logos and trademarks used here in are the properties of their respective owners.

WELCOME

Congratulations on the purchase of your iDatalink Maestro RR Radio replacement solution. You are now a few simple steps away from enjoying your new car radio with enhanced features.

Before starting your installation, please ensure that your iDatalink Maestro module is programmed with the correct firmware for your vehicle and that you carefully review the install guide.

Please note that Maestro RR will only retain functionalities that were originally available in the vehicle.

NEED HELP?

 **1 866 427-2999**

 support@idatalink.com

 maestro.idatalink.com/support
www.12voltdata.com/forum

TABLE OF CONTENTS

Installation Instructions	3
Wiring Diagram	5
Vehicle Wire Reference Chart	6
Radio Wire Reference Chart	7

INSTALLATION INSTRUCTIONS

STEP 1

- Unbox the aftermarket radio and locate its main harness.
- Connect the wires shown on the next page from aftermarket radio main harness to the VW1 T-harness and match the wire functions.

STEP 2

- Connect the factory harness to the VW1 T-harness.
- Mate the male and female 4 pin WHITE connectors of the VW1 T-harness.
- Do not use any of the RCA plugs (WHITE, GRAY, GREEN & PURPLE) of the VW1 T-harness.

STEP 3

- Access the OBDII connector located under the driver side dashboard.
- Connect the BROWN /RED wire of the VW1 T-harness to the wire located at pin 6 of the OBDII connector. (See the vehicle wire chart reference for wire colors)
- Connect the BROWN /YELLOW wire of the VW1 T-harness to the wire located at pin 14 of the OBDII connector. (See the vehicle wire chart reference for wire colors)
- Do not use the GREEN/WHITE wire.

STEP 4

- Plug the aftermarket radio harnesses into the aftermarket radio.
- Plug the Data cable to the data port of the aftermarket radio.
- Insert the Audio cable into the iDatalink 3.5 mm audio jack of the aftermarket radio.

STEP 5

- Connect all the harnesses to the Maestro RR module then proceed to module setup.

The module is now ready to be used.

Insert the aftermarket radio in the dashboard housing and test all the functionalities.

Reassemble the dashboard carefully.

Note: The OEM backup camera cannot be retained with this solution. It can be retained by using a third party component to composite video converter.

OEM BLUETOOTH SETUP

Only one Bluetooth system can be set for hands free calling. This must be determined before installation. Both the factory and aftermarket systems can be used for Bluetooth audio streaming. If the aftermarket Bluetooth is chosen for hands free calling, the aftermarket microphone must be installed in the vehicle and the factory Bluetooth module must be unplugged. In most vehicles, it is located under the passenger seat. If the vehicle is equipped with Bluetooth but there is no Bluetooth module under the passenger's seat then the Bluetooth system is built into the MDI module. Unplugging the MDI module will disable both factory systems.

2013 Kenwood Radios:

For these radio models, the OEM Bluetooth is turned OFF by default. To turn ON the OEM Bluetooth, insert the key into the ignition and turn it to the ACC position. The Radio will turn on and the setup screen will appear. Scroll to the bottom and select the vehicle set up menu by pressing SET. Go to the option OEM Bluetooth and select ON. Press the return arrow then scroll to the bottom of the page select FINISH.

2014 Kenwood Radios:

For these radio models, the OEM Bluetooth is turned ON by default. To turn OFF the OEM Bluetooth, insert the key into the ignition and turn it to the ACC position. The radio will turn ON and the setup screen will appear. Scroll to the bottom and select the vehicle set up menu by pressing SET. Go to the option OEM Bluetooth and select OFF.

2014 Alpine Radios:

For these radio models, the OEM Bluetooth is turned ON by default. To turn OFF the OEM Bluetooth, insert the key into the ignition and turn it to the ACC position. The radio will turn ON and the main screen will appear. Select the settings button, in the top right corner, then select GENERAL. Select INTEGRATION SETUP then select HANDS FREE CONNECTION. Two options will be available ON or OFF, select OFF.

INSTALLATION INSTRUCTIONS

AIRBAG WARNING LIGHT

If an airbag warning light turns ON after starting the vehicle without having the airbag light plugged in, select Clear Airbag Warning to turn OFF that warning light.

Kenwood Radios:

Main Menu>>Setup>>Sources>>Volkswagen Setup>>Vehicle Features>>Clear Airbag Warning

Alpine Radios:

Settings>>General>>Idatalink Setup>> Maestro Module>>Volkswagen Setup>>Vehicle Features>>Clear Airbag Warning

TROUBLESHOOTING TIPS:

- To reset the module back to its factory settings, turn the key to the OFF position then disconnect all connectors from the module. Press and hold the module's programming button and connect all the connectors back to the module. Wait, the module's LED will flash RED rapidly (this may take up to 10 seconds). Release the programming button. Wait, the LED will turn solid GREEN for 2 seconds.
- For technical assistance call 1-866-427-2999 or e-mail "support@idatalink.com". Visit us at "maestro.idatalink.com/support" and "www.12voltdata.com/forum/"

WIRING DIAGRAM

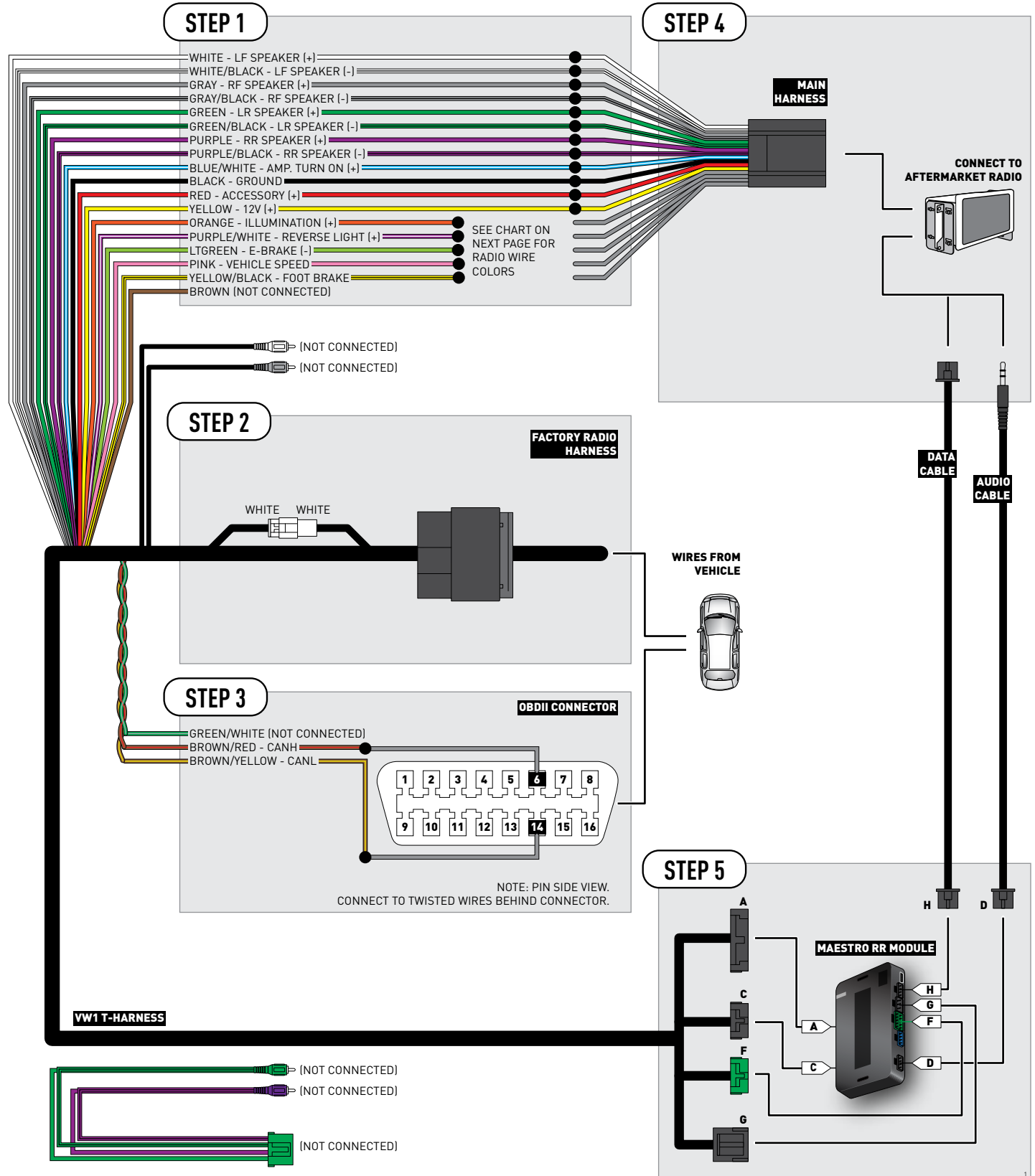

VEHICLE WIRE REFERENCE CHART

Wire Description	Connector Name	Connector Color	Connector Type	Position	Wire Color	Polarity	Wire Location
CanH	A	~	16 pin	06	Orange/Black	(DATA)	OBDII connector, under driver side dash
CanL	A	~	16 pin	14	Orange/Brown	(DATA)	OBDII connector, under driver side dash

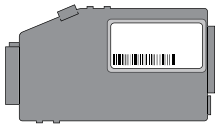

Warning: Factory Compass Module

If your vehicle is equipped with a factory compass module and you are installing an aftermarket radio that supplies navigation information to the MFD of the vehicle, disconnect the factory compass module located under the headliner at the rear of the vehicle.

RADIO WIRE REFERENCE CHART

Wire Description	Polarity	Wire Color on Maestro T-Harness	Wire Color on Alpine cable	Wire Color on Kenwood cable	Wire Color on Pioneer cable
Illumination	(+)	Orange	N/A	Orange/White	Orange/White
Reverse Light	(+)	Purple/White	Orange/White	Purple/White	Purple/White
E-Brake	(-)	Lt Green	Yellow/Blue	Lt Green	Lt Green
Foot Brake	(+)	Yellow/Black	Yellow/Black	N/A	N/A
VSS (vehicle speed sensor)	(DATA)	Pink	Green/White	N/A	Pink



INSTALL GUIDE VOLKSWAGEN GTI 2006-2009

RETAINS STEERING WHEEL CONTROLS, MFD, MDI, VW BLUETOOTH AND MORE!



PRODUCTS REQUIRED

iDatalink Maestro RR Radio Replacement Interface
iDatalink Maestro VW1 Installation Harness

OPTIONAL ACCESSORIES

None

PROGRAMMED FIRMWARE

ADS-RR(SR)-VW01-DS

NOTICE: Automotive Data Solutions Inc. (ADS) recommends having this installation performed by a certified technician. Logos and trademarks used here in are the properties of their respective owners.

WELCOME

Congratulations on the purchase of your iDatalink Maestro RR Radio replacement solution. You are now a few simple steps away from enjoying your new car radio with enhanced features.

Before starting your installation, please ensure that your iDatalink Maestro module is programmed with the correct firmware for your vehicle and that you carefully review the install guide.

Please note that Maestro RR will only retain functionalities that were originally available in the vehicle.

NEED HELP?

 **1 866 427-2999**

 support@idatalink.com

 maestro.idatalink.com/support
www.12voltdata.com/forum

TABLE OF CONTENTS

Installation Instructions	3
Wiring Diagram	5
Vehicle Wire Reference Chart	6
Radio Wire Reference Chart	7

INSTALLATION INSTRUCTIONS

STEP 1

- Unbox the aftermarket radio and locate its main harness.
- Connect the wires shown on the next page from aftermarket radio main harness to the VW1 T-harness and match the wire functions.

STEP 2

- Connect the factory harness to the VW1 T-harness.
- Mate the male and female 4 pin WHITE connectors of the VW1 T-harness.
- Do not use any of the RCA plugs (WHITE, GRAY, GREEN & PURPLE) of the VW1 T-harness.

STEP 3

- Access the OBDII connector located under the driver side dashboard.
- Connect the BROWN /RED wire of the VW1 T-harness to the wire located at pin 6 of the OBDII connector. (See the vehicle wire chart reference for wire colors)
- Connect the BROWN /YELLOW wire of the VW1 T-harness to the wire located at pin 14 of the OBDII connector. (See the vehicle wire chart reference for wire colors)
- Do not use the GREEN/WHITE wire.

STEP 4

- Plug the aftermarket radio harnesses into the aftermarket radio.
- Plug the Data cable to the data port of the aftermarket radio.
- Insert the Audio cable into the iDatalink 3.5 mm audio jack of the aftermarket radio.

STEP 5

- Connect all the harnesses to the Maestro RR module then proceed to module setup.

The module is now ready to be used.

Insert the aftermarket radio in the dashboard housing and test all the functionalities.

Reassemble the dashboard carefully.

Note: The OEM backup camera cannot be retained with this solution. It can be retained by using a third party component to composite video converter.

OEM BLUETOOTH SETUP

Only one Bluetooth system can be set for hands free calling. This must be determined before installation. Both the factory and aftermarket systems can be used for Bluetooth audio streaming. If the aftermarket Bluetooth is chosen for hands free calling, the aftermarket microphone must be installed in the vehicle and the factory Bluetooth module must be unplugged. In most vehicles, it is located under the passenger seat. If the vehicle is equipped with Bluetooth but there is no Bluetooth module under the passenger's seat then the Bluetooth system is built into the MDI module. Unplugging the MDI module will disable both factory systems.

2013 Kenwood Radios:

For these radio models, the OEM Bluetooth is turned OFF by default. To turn ON the OEM Bluetooth, insert the key into the ignition and turn it to the ACC position. The Radio will turn on and the setup screen will appear. Scroll to the bottom and select the vehicle set up menu by pressing SET. Go to the option OEM Bluetooth and select ON. Press the return arrow then scroll to the bottom of the page select FINISH.

2014 Kenwood Radios:

For these radio models, the OEM Bluetooth is turned ON by default. To turn OFF the OEM Bluetooth, insert the key into the ignition and turn it to the ACC position. The radio will turn ON and the setup screen will appear. Scroll to the bottom and select the vehicle set up menu by pressing SET. Go to the option OEM Bluetooth and select OFF.

2014 Alpine Radios:

For these radio models, the OEM Bluetooth is turned ON by default. To turn OFF the OEM Bluetooth, insert the key into the ignition and turn it to the ACC position. The radio will turn ON and the main screen will appear. Select the settings button, in the top right corner, then select GENERAL. Select INTEGRATION SETUP then select HANDS FREE CONNECTION. Two options will be available ON or OFF, select OFF.

INSTALLATION INSTRUCTIONS

AIRBAG WARNING LIGHT

If an airbag warning light turns ON after starting the vehicle without having the airbag light plugged in, select Clear Airbag Warning to turn OFF that warning light.

Kenwood Radios:

Main Menu>>Setup>>Sources>>Volkswagen Setup>>Vehicle Features>>Clear Airbag Warning

Alpine Radios:

Settings>>General>>Idatalink Setup>> Maestro Module>>Volkswagen Setup>>Vehicle Features>>Clear Airbag Warning

TROUBLESHOOTING TIPS:

- To reset the module back to its factory settings, turn the key to the OFF position then disconnect all connectors from the module. Press and hold the module's programming button and connect all the connectors back to the module. Wait, the module's LED will flash RED rapidly (this may take up to 10 seconds). Release the programming button. Wait, the LED will turn solid GREEN for 2 seconds.
- For technical assistance call 1-866-427-2999 or e-mail "support@idatalink.com". Visit us at "maestro.idatalink.com/support" and "www.12voltdata.com/forum/"

WIRING DIAGRAM

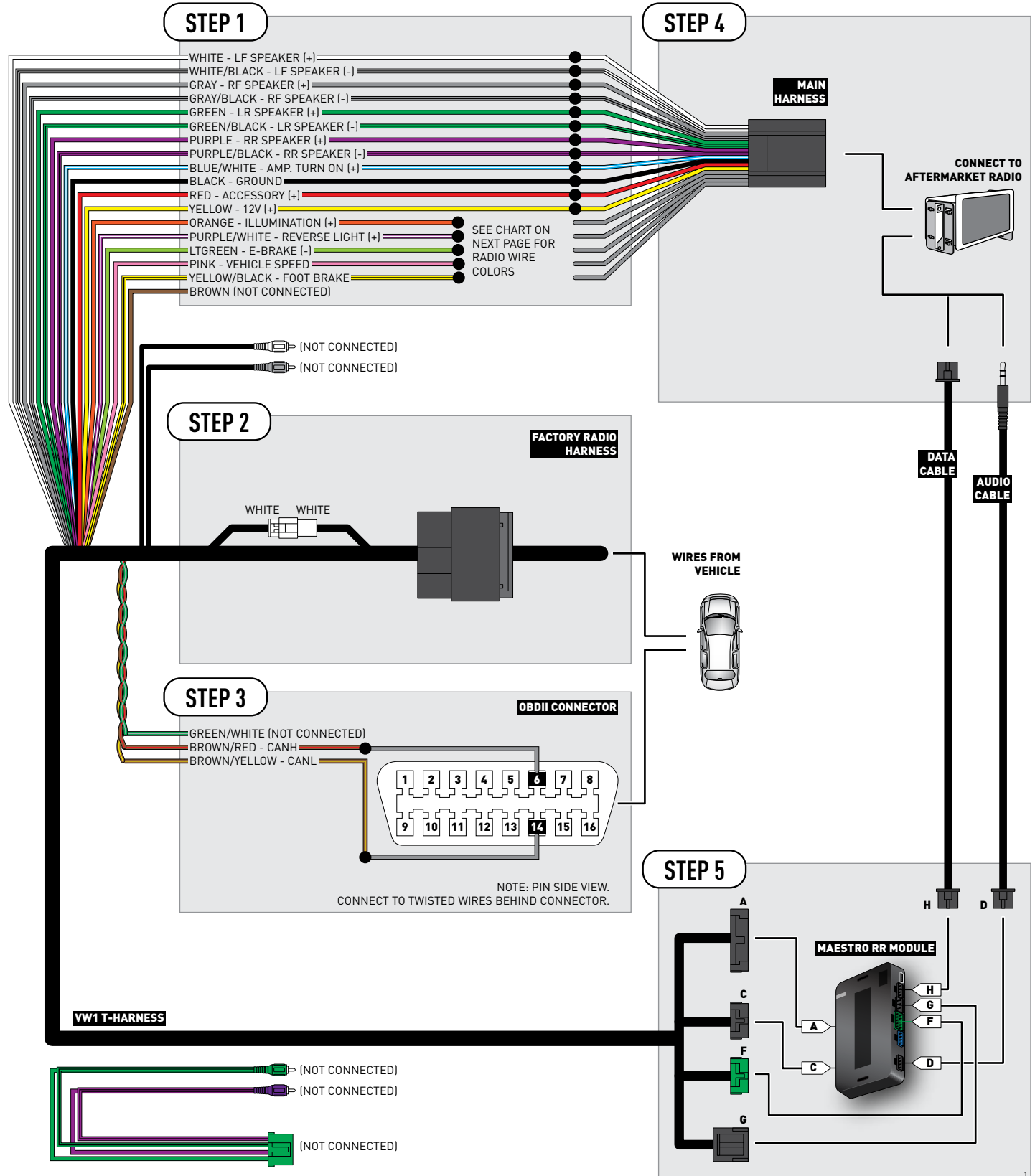

VEHICLE WIRE REFERENCE CHART

Wire Description	Connector Name	Connector Color	Connector Type	Position	Wire Color	Polarity	Wire Location
CanH	A	~	16 pin	06	Orange/Black	[DATA]	OBDII connector, under driver side dash
CanL	A	~	16 pin	14	Orange/Brown	[DATA]	OBDII connector, under driver side dash

RADIO WIRE REFERENCE CHART

Wire Description	Polarity	Wire Color on Maestro T-Harness	Wire Color on Alpine cable	Wire Color on Kenwood cable	Wire Color on Pioneer cable
Illumination	(+)	Orange	N/A	Orange/White	Orange/White
Reverse Light	(+)	Purple/White	Orange/White	Purple/White	Purple/White
E-Brake	(-)	Lt Green	Yellow/Blue	Lt Green	Lt Green
Foot Brake	(+)	Yellow/Black	Yellow/Black	N/A	N/A
VSS (vehicle speed sensor)	(DATA)	Pink	Green/White	N/A	Pink



INSTALL GUIDE VOLKSWAGEN GTI 2010-2014

RETAINS STEERING WHEEL CONTROLS, MFD, MDI, VW BLUETOOTH AND MORE!



PRODUCTS REQUIRED

iDatalink Maestro RR Radio Replacement Interface
iDatalink Maestro VW1 Installation Harness

OPTIONAL ACCESSORIES

None

PROGRAMMED FIRMWARE

ADS-RR(SR)-VW01-DS

NOTICE: Automotive Data Solutions Inc. (ADS) recommends having this installation performed by a certified technician. Logos and trademarks used here in are the properties of their respective owners.

WELCOME

Congratulations on the purchase of your iDatalink Maestro RR Radio replacement solution. You are now a few simple steps away from enjoying your new car radio with enhanced features.

Before starting your installation, please ensure that your iDatalink Maestro module is programmed with the correct firmware for your vehicle and that you carefully review the install guide.

Please note that Maestro RR will only retain functionalities that were originally available in the vehicle.

NEED HELP?

 **1 866 427-2999**

 **support@idatalink.com**

 **maestro.idatalink.com/support
www.12voltdata.com/forum**

TABLE OF CONTENTS

Installation Instructions	3
Wiring Diagram	5
Vehicle Wire Reference Chart	6
Radio Wire Reference Chart	7

INSTALLATION INSTRUCTIONS

STEP 1

- Unbox the aftermarket radio and locate its main harness.
- Connect the wires shown on the next page from aftermarket radio main harness to the VW1 T-harness and match the wire functions.

STEP 2

- Connect the factory harness to the VW1 T-harness.
- Mate the male and female 4 pin WHITE connectors of the VW1 T-harness.
- Do not use any of the RCA plugs (WHITE, GRAY, GREEN & PURPLE) of the VW1 T-harness.

STEP 3

- Access the OBDII connector located under the driver side dashboard.
- Connect the BROWN /RED wire of the VW1 T-harness to the wire located at pin 6 of the OBDII connector. (See the vehicle wire chart reference for wire colors)
- Connect the BROWN /YELLOW wire of the VW1 T-harness to the wire located at pin 14 of the OBDII connector. (See the vehicle wire chart reference for wire colors)
- Do not use the GREEN/WHITE wire.

STEP 4

- Plug the aftermarket radio harnesses into the aftermarket radio.
- Plug the Data cable to the data port of the aftermarket radio.
- Insert the Audio cable into the iDatalink 3.5 mm audio jack of the aftermarket radio.

STEP 5

- Connect all the harnesses to the Maestro RR module then proceed to module setup.

The module is now ready to be used.

Insert the aftermarket radio in the dashboard housing and test all the functionalities.

Reassemble the dashboard carefully.

Note: The OEM backup camera cannot be retained with this solution. It can be retained by using a third party component to composite video converter.

OEM BLUETOOTH SETUP

Only one Bluetooth system can be set for hands free calling. This must be determined before installation. Both the factory and aftermarket systems can be used for Bluetooth audio streaming. If the aftermarket Bluetooth is chosen for hands free calling, the aftermarket microphone must be installed in the vehicle and the factory Bluetooth module must be unplugged. In most vehicles, it is located under the passenger seat. If the vehicle is equipped with Bluetooth but there is no Bluetooth module under the passenger's seat then the Bluetooth system is built into the MDI module. Unplugging the MDI module will disable both factory systems.

2013 Kenwood Radios:

For these radio models, the OEM Bluetooth is turned OFF by default. To turn ON the OEM Bluetooth, insert the key into the ignition and turn it to the ACC position. The Radio will turn on and the setup screen will appear. Scroll to the bottom and select the vehicle set up menu by pressing SET. Go to the option OEM Bluetooth and select ON. Press the return arrow then scroll to the bottom of the page select FINISH.

2014 Kenwood Radios:

For these radio models, the OEM Bluetooth is turned ON by default. To turn OFF the OEM Bluetooth, insert the key into the ignition and turn it to the ACC position. The radio will turn ON and the setup screen will appear. Scroll to the bottom and select the vehicle set up menu by pressing SET. Go to the option OEM Bluetooth and select OFF.

2014 Alpine Radios:

For these radio models, the OEM Bluetooth is turned ON by default. To turn OFF the OEM Bluetooth, insert the key into the ignition and turn it to the ACC position. The radio will turn ON and the main screen will appear. Select the settings button, in the top right corner, then select GENERAL. Select INTEGRATION SETUP then select HANDS FREE CONNECTION. Two options will be available ON or OFF, select OFF.

INSTALLATION INSTRUCTIONS

AIRBAG WARNING LIGHT

If an airbag warning light turns ON after starting the vehicle without having the airbag light plugged in, select Clear Airbag Warning to turn OFF that warning light.

Kenwood Radios:

Main Menu>>Setup>>Sources>>Volkswagen Setup>>Vehicle Features>>Clear Airbag Warning

Alpine Radios:

Settings>>General>>Idatalink Setup>> Maestro Module>>Volkswagen Setup>>Vehicle Features>>Clear Airbag Warning

TROUBLESHOOTING TIPS:

- To reset the module back to its factory settings, turn the key to the OFF position then disconnect all connectors from the module. Press and hold the module's programming button and connect all the connectors back to the module. Wait, the module's LED will flash RED rapidly (this may take up to 10 seconds). Release the programming button. Wait, the LED will turn solid GREEN for 2 seconds.
- For technical assistance call 1-866-427-2999 or e-mail "support@idatalink.com". Visit us at "maestro.idatalink.com/support" and "www.12voldata.com/forum/"

WIRING DIAGRAM

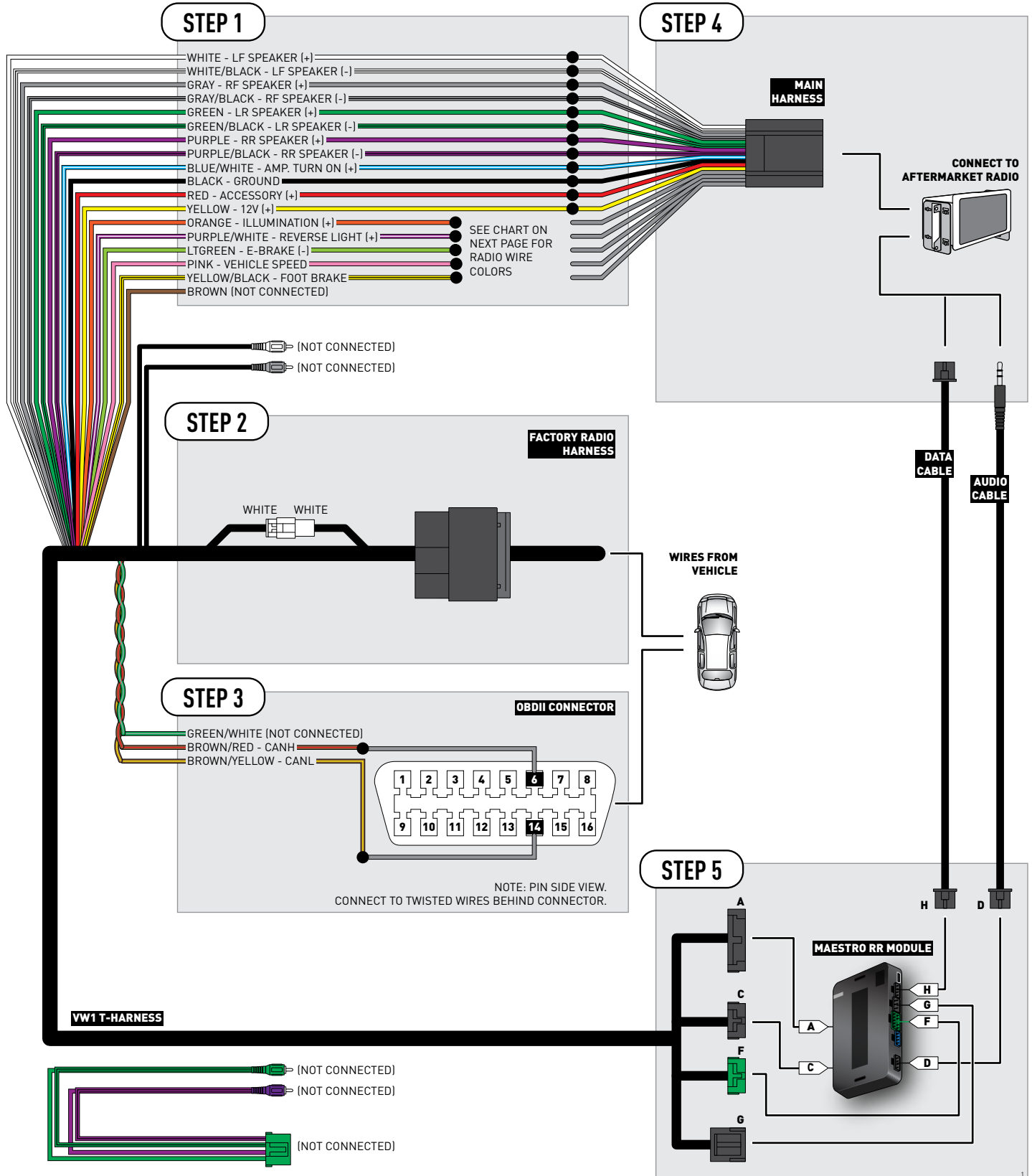

VEHICLE WIRE REFERENCE CHART

Wire Description	Connector Name	Connector Color	Connector Type	Position	Wire Color	Polarity	Wire Location
CanH	A	~	16 pin	06	Orange/Black	(DATA)	OBDII connector, under driver side dash
CanL	A	~	16 pin	14	Orange/Brown	(DATA)	OBDII connector, under driver side dash

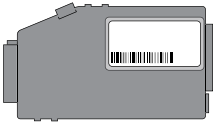

Warning: Factory Compass Module

If your vehicle is equipped with a factory compass module and you are installing an aftermarket radio that supplies navigation information to the MFD of the vehicle, disconnect the factory compass module located under the headliner at the rear of the vehicle.

RADIO WIRE REFERENCE CHART

Wire Description	Polarity	Wire Color on Maestro T-Harness	Wire Color on Alpine cable	Wire Color on Kenwood cable	Wire Color on Pioneer cable
Illumination	(+)	Orange	N/A	Orange/White	Orange/White
Reverse Light	(+)	Purple/White	Orange/White	Purple/White	Purple/White
E-Brake	(-)	Lt Green	Yellow/Blue	Lt Green	Lt Green
Foot Brake	(+)	Yellow/Black	Yellow/Black	N/A	N/A
VSS (vehicle speed sensor)	(DATA)	Pink	Green/White	N/A	Pink



INSTALL GUIDE VOLKSWAGEN JETTA 2006-2010

RETAINS STEERING WHEEL CONTROLS, MFD, MDI, VW BLUETOOTH AND MORE!



PRODUCTS REQUIRED

iDatalink Maestro RR Radio Replacement Interface
iDatalink Maestro VW1 Installation Harness

OPTIONAL ACCESSORIES

None

PROGRAMMED FIRMWARE

ADS-RR(SR)-VW01-DS

NOTICE: Automotive Data Solutions Inc. (ADS) recommends having this installation performed by a certified technician. Logos and trademarks used here in are the properties of their respective owners.

WELCOME

Congratulations on the purchase of your iDatalink Maestro RR Radio replacement solution. You are now a few simple steps away from enjoying your new car radio with enhanced features.

Before starting your installation, please ensure that your iDatalink Maestro module is programmed with the correct firmware for your vehicle and that you carefully review the install guide.

Please note that Maestro RR will only retain functionalities that were originally available in the vehicle.

NEED HELP?

 **1 866 427-2999**

 **support@idatalink.com**

 **maestro.idatalink.com/support
www.12voltdata.com/forum**

TABLE OF CONTENTS

Installation Instructions	3
Wiring Diagram	5
Vehicle Wire Reference Chart	6
Radio Wire Reference Chart	7

INSTALLATION INSTRUCTIONS

STEP 1

- Unbox the aftermarket radio and locate its main harness.
- Connect the wires shown on the next page from aftermarket radio main harness to the VW1 T-harness and match the wire functions.

STEP 2

- Connect the factory harness to the VW1 T-harness.
- Mate the male and female 4 pin WHITE connectors of the VW1 T-harness.
- Do not use any of the RCA plugs (WHITE, GRAY, GREEN & PURPLE) of the VW1 T-harness.

STEP 3

- Access the OBDII connector located under the driver side dashboard.
- Connect the BROWN /RED wire of the VW1 T-harness to the wire located at pin 6 of the OBDII connector. (See the vehicle wire chart reference for wire colors)
- Connect the BROWN /YELLOW wire of the VW1 T-harness to the wire located at pin 14 of the OBDII connector. (See the vehicle wire chart reference for wire colors)
- Do not use the GREEN/WHITE wire.

STEP 4

- Plug the aftermarket radio harnesses into the aftermarket radio.
- Plug the Data cable to the data port of the aftermarket radio.
- Insert the Audio cable into the iDatalink 3.5 mm audio jack of the aftermarket radio.

STEP 5

- Connect all the harnesses to the Maestro RR module then proceed to module setup.

The module is now ready to be used.

Insert the aftermarket radio in the dashboard housing and test all the functionalities.

Reassemble the dashboard carefully.

Note: The OEM backup camera cannot be retained with this solution. It can be retained by using a third party component to composite video converter.

OEM BLUETOOTH SETUP

Only one Bluetooth system can be set for hands free calling. This must be determined before installation. Both the factory and aftermarket systems can be used for Bluetooth audio streaming. If the aftermarket Bluetooth is chosen for hands free calling, the aftermarket microphone must be installed in the vehicle and the factory Bluetooth module must be unplugged. In most vehicles, it is located under the passenger seat. If the vehicle is equipped with Bluetooth but there is no Bluetooth module under the passenger's seat then the Bluetooth system is built into the MDI module. Unplugging the MDI module will disable both factory systems.

2013 Kenwood Radios:

For these radio models, the OEM Bluetooth is turned OFF by default. To turn ON the OEM Bluetooth, insert the key into the ignition and turn it to the ACC position. The Radio will turn on and the setup screen will appear. Scroll to the bottom and select the vehicle set up menu by pressing SET. Go to the option OEM Bluetooth and select ON. Press the return arrow then scroll to the bottom of the page select FINISH.

2014 Kenwood Radios:

For these radio models, the OEM Bluetooth is turned ON by default. To turn OFF the OEM Bluetooth, insert the key into the ignition and turn it to the ACC position. The radio will turn ON and the setup screen will appear. Scroll to the bottom and select the vehicle set up menu by pressing SET. Go to the option OEM Bluetooth and select OFF.

2014 Alpine Radios:

For these radio models, the OEM Bluetooth is turned ON by default. To turn OFF the OEM Bluetooth, insert the key into the ignition and turn it to the ACC position. The radio will turn ON and the main screen will appear. Select the settings button, in the top right corner, then select GENERAL. Select INTEGRATION SETUP then select HANDS FREE CONNECTION. Two options will be available ON or OFF, select OFF.

INSTALLATION INSTRUCTIONS

AIRBAG WARNING LIGHT

If an airbag warning light turns ON after starting the vehicle without having the airbag light plugged in, select Clear Airbag Warning to turn OFF that warning light.

Kenwood Radios:

Main Menu>>Setup>>Sources>>Volkswagen Setup>>Vehicle Features>>Clear Airbag Warning

Alpine Radios:

Settings>>General>>Idatalink Setup>> Maestro Module>>Volkswagen Setup>>Vehicle Features>>Clear Airbag Warning

TROUBLESHOOTING TIPS:

- To reset the module back to its factory settings, turn the key to the OFF position then disconnect all connectors from the module. Press and hold the module's programming button and connect all the connectors back to the module. Wait, the module's LED will flash RED rapidly (this may take up to 10 seconds). Release the programming button. Wait, the LED will turn solid GREEN for 2 seconds.
- For technical assistance call 1-866-427-2999 or e-mail "support@idatalink.com". Visit us at "maestro.idatalink.com/support" and "www.12voldata.com/forum/"

WIRING DIAGRAM

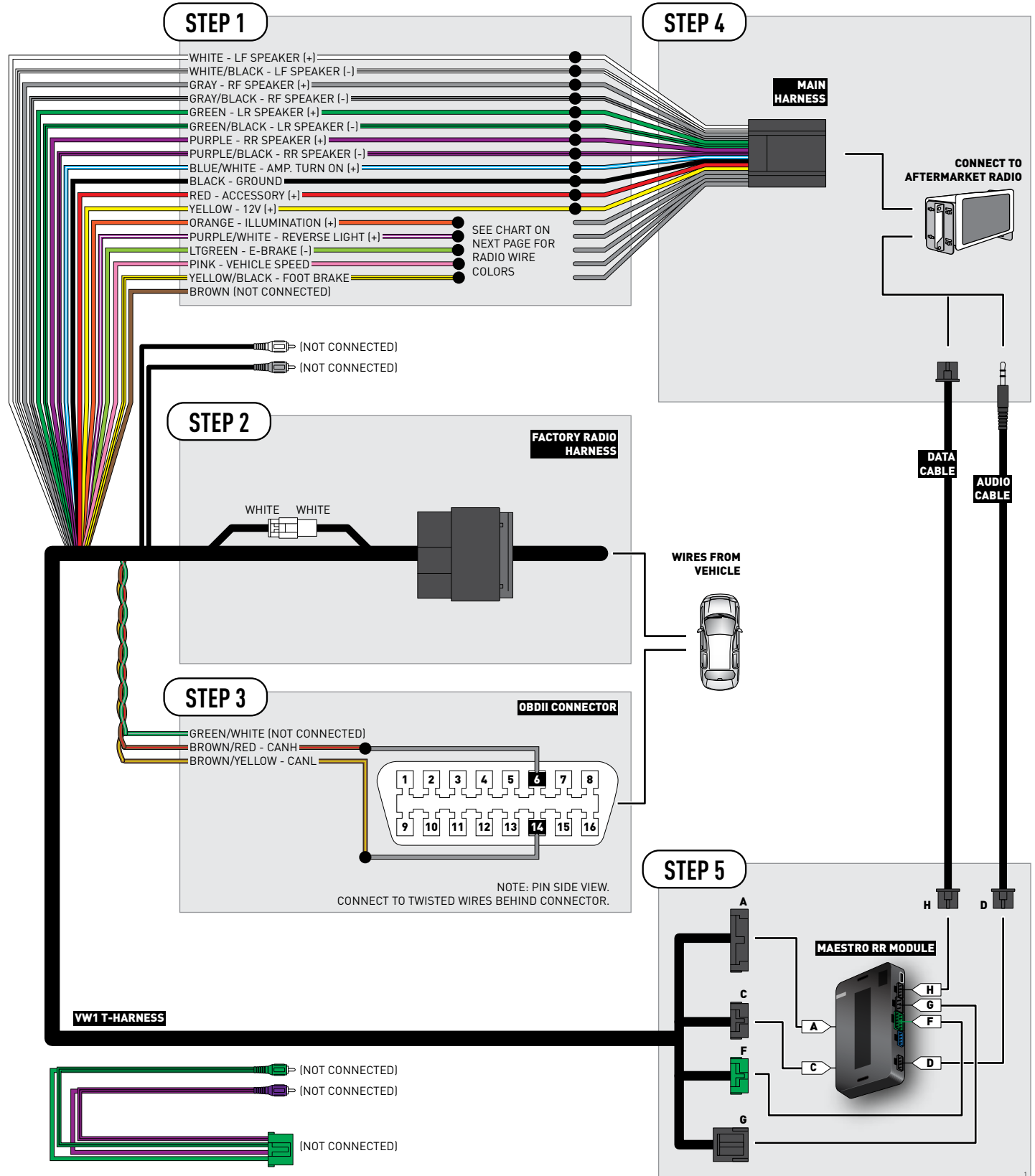

VEHICLE WIRE REFERENCE CHART

Wire Description	Connector Name	Connector Color	Connector Type	Position	Wire Color	Polarity	Wire Location
CanH	A	~	16 pin	06	Orange/Black	(DATA)	OBDII connector, under driver side dash
CanL	A	~	16 pin	14	Orange/Brown	(DATA)	OBDII connector, under driver side dash

RADIO WIRE REFERENCE CHART

Wire Description	Polarity	Wire Color on Maestro T-Harness	Wire Color on Alpine cable	Wire Color on Kenwood cable	Wire Color on Pioneer cable
Illumination	(+)	Orange	N/A	Orange/White	Orange/White
Reverse Light	(+)	Purple/White	Orange/White	Purple/White	Purple/White
E-Brake	(-)	Lt Green	Yellow/Blue	Lt Green	Lt Green
Foot Brake	(+)	Yellow/Black	Yellow/Black	N/A	N/A
VSS (vehicle speed sensor)	(DATA)	Pink	Green/White	N/A	Pink



INSTALL GUIDE VOLKSWAGEN JETTA 2011-2015

RETAINS STEERING WHEEL CONTROLS, MFD, MDI, VW BLUETOOTH AND MORE!



PRODUCTS REQUIRED

iDatalink Maestro RR Radio Replacement Interface
iDatalink Maestro VW1 Installation Harness

OPTIONAL ACCESSORIES

None

PROGRAMMED FIRMWARE

ADS-RR(SR)-VW01-DS

NOTICE: Automotive Data Solutions Inc. (ADS) recommends having this installation performed by a certified technician. Logos and trademarks used here in are the properties of their respective owners.

WELCOME

Congratulations on the purchase of your iDatalink Maestro RR Radio replacement solution. You are now a few simple steps away from enjoying your new car radio with enhanced features.

Before starting your installation, please ensure that your iDatalink Maestro module is programmed with the correct firmware for your vehicle and that you carefully review the install guide.

Please note that Maestro RR will only retain functionalities that were originally available in the vehicle.

NEED HELP?

 **1 866 427-2999**

 support@idatalink.com

 maestro.idatalink.com/support
www.12voltdata.com/forum

TABLE OF CONTENTS

Installation Instructions	3
Wiring Diagram	5
Vehicle Wire Reference Chart	6
Radio Wire Reference Chart	7

INSTALLATION INSTRUCTIONS

STEP 1

- Unbox the aftermarket radio and locate its main harness.
- Connect the wires shown on the next page from aftermarket radio main harness to the VW1 T-harness and match the wire functions.

STEP 2

- Connect the factory harness to the VW1 T-harness.
- Mate the male and female 4 pin WHITE connectors of the VW1 T-harness.
- Do not use any of the RCA plugs (WHITE, GRAY, GREEN & PURPLE) of the VW1 T-harness.

STEP 3

- Access the OBDII connector located under the driver side dashboard.
- Connect the BROWN /RED wire of the VW1 T-harness to the wire located at pin 6 of the OBDII connector. (See the vehicle wire chart reference for wire colors)
- Connect the BROWN /YELLOW wire of the VW1 T-harness to the wire located at pin 14 of the OBDII connector. (See the vehicle wire chart reference for wire colors)
- Do not use the GREEN/WHITE wire.

STEP 4

- Plug the aftermarket radio harnesses into the aftermarket radio.
- Plug the Data cable to the data port of the aftermarket radio.
- Insert the Audio cable into the iDatalink 3.5 mm audio jack of the aftermarket radio.

STEP 5

- Connect all the harnesses to the Maestro RR module then proceed to module setup.

The module is now ready to be used.

Insert the aftermarket radio in the dashboard housing and test all the functionalities.

Reassemble the dashboard carefully.

Note: The OEM backup camera cannot be retained with this solution. It can be retained by using a third party component to composite video converter.

OEM BLUETOOTH SETUP

Only one Bluetooth system can be set for hands free calling. This must be determined before installation. Both the factory and aftermarket systems can be used for Bluetooth audio streaming. If the aftermarket Bluetooth is chosen for hands free calling, the aftermarket microphone must be installed in the vehicle and the factory Bluetooth module must be unplugged. In most vehicles, it is located under the passenger seat. If the vehicle is equipped with Bluetooth but there is no Bluetooth module under the passenger's seat then the Bluetooth system is built into the MDI module. Unplugging the MDI module will disable both factory systems.

2013 Kenwood Radios:

For these radio models, the OEM Bluetooth is turned OFF by default. To turn ON the OEM Bluetooth, insert the key into the ignition and turn it to the ACC position. The Radio will turn on and the setup screen will appear. Scroll to the bottom and select the vehicle set up menu by pressing SET. Go to the option OEM Bluetooth and select ON. Press the return arrow then scroll to the bottom of the page select FINISH.

2014 Kenwood Radios:

For these radio models, the OEM Bluetooth is turned ON by default. To turn OFF the OEM Bluetooth, insert the key into the ignition and turn it to the ACC position. The radio will turn ON and the setup screen will appear. Scroll to the bottom and select the vehicle set up menu by pressing SET. Go to the option OEM Bluetooth and select OFF.

2014 Alpine Radios:

For these radio models, the OEM Bluetooth is turned ON by default. To turn OFF the OEM Bluetooth, insert the key into the ignition and turn it to the ACC position. The radio will turn ON and the main screen will appear. Select the settings button, in the top right corner, then select GENERAL. Select INTEGRATION SETUP then select HANDS FREE CONNECTION. Two options will be available ON or OFF, select OFF.

INSTALLATION INSTRUCTIONS

AIRBAG WARNING LIGHT

If an airbag warning light turns ON after starting the vehicle without having the airbag light plugged in, select Clear Airbag Warning to turn OFF that warning light.

Kenwood Radios:

Main Menu>>Setup>>Sources>>Volkswagen Setup>>Vehicle Features>>Clear Airbag Warning

Alpine Radios:

Settings>>General>>Idatalink Setup>> Maestro Module>>Volkswagen Setup>>Vehicle Features>>Clear Airbag Warning

TROUBLESHOOTING TIPS:

- To reset the module back to its factory settings, turn the key to the OFF position then disconnect all connectors from the module. Press and hold the module's programming button and connect all the connectors back to the module. Wait, the module's LED will flash RED rapidly (this may take up to 10 seconds). Release the programming button. Wait, the LED will turn solid GREEN for 2 seconds.
- For technical assistance call 1-866-427-2999 or e-mail "support@idatalink.com". Visit us at "maestro.idatalink.com/support" and "www.12voltdata.com/forum/"

WIRING DIAGRAM

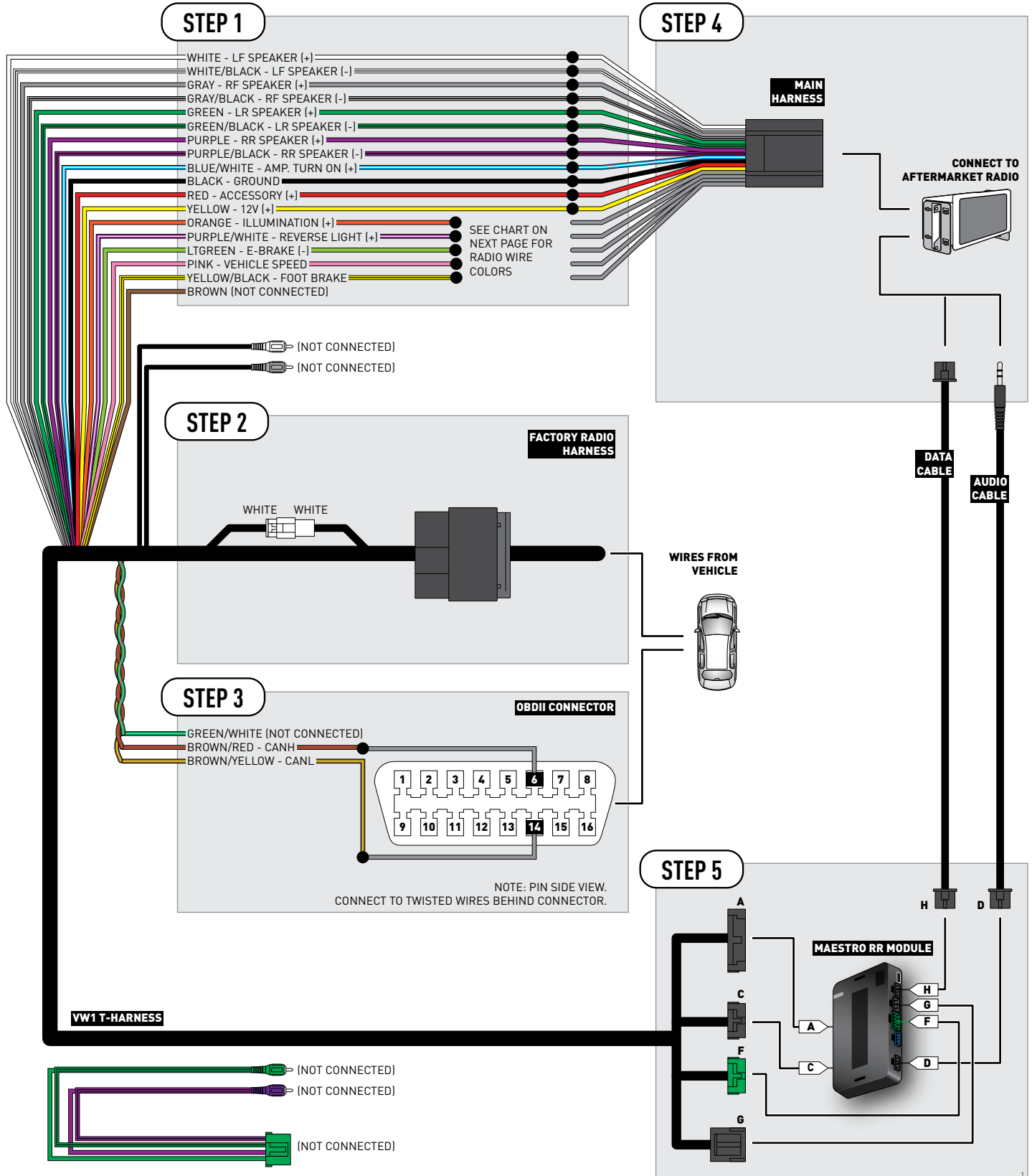

VEHICLE WIRE REFERENCE CHART

Wire Description	Connector Name	Connector Color	Connector Type	Position	Wire Color	Polarity	Wire Location
CanH	A	~	16 pin	06	Orange/Black	(DATA)	OBDII connector, under driver side dash
CanL	A	~	16 pin	14	Orange/Brown	(DATA)	OBDII connector, under driver side dash

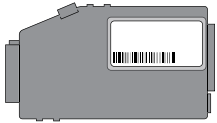

Warning: Factory Compass Module

If your vehicle is equipped with a factory compass module and you are installing an aftermarket radio that supplies navigation information to the MFD of the vehicle, disconnect the factory compass module located under the trunk Lid.

RADIO WIRE REFERENCE CHART

Wire Description	Polarity	Wire Color on Maestro T-Harness	Wire Color on Alpine cable	Wire Color on Kenwood cable	Wire Color on Pioneer cable
Illumination	(+)	Orange	N/A	Orange/White	Orange/White
Reverse Light	(+)	Purple/White	Orange/White	Purple/White	Purple/White
E-Brake	(-)	Lt Green	Yellow/Blue	Lt Green	Lt Green
Foot Brake	(+)	Yellow/Black	Yellow/Black	N/A	N/A
VSS (vehicle speed sensor)	(DATA)	Pink	Green/White	N/A	Pink



INSTALL GUIDE VOLKSWAGEN PASSAT 2006-2009

RETAINS STEERING WHEEL CONTROLS, MFD, MDI, VW BLUETOOTH AND MORE!



PRODUCTS REQUIRED

iDatalink Maestro RR Radio Replacement Interface
iDatalink Maestro VW1 Installation Harness

OPTIONAL ACCESSORIES

None

PROGRAMMED FIRMWARE

ADS-RR(SR)-VW01-DS

NOTICE: Automotive Data Solutions Inc. (ADS) recommends having this installation performed by a certified technician. Logos and trademarks used here in are the properties of their respective owners.

WELCOME

Congratulations on the purchase of your iDatalink Maestro RR Radio replacement solution. You are now a few simple steps away from enjoying your new car radio with enhanced features.

Before starting your installation, please ensure that your iDatalink Maestro module is programmed with the correct firmware for your vehicle and that you carefully review the install guide.

Please note that Maestro RR will only retain functionalities that were originally available in the vehicle.

NEED HELP?

 **1 866 427-2999**

 support@idatalink.com

 maestro.idatalink.com/support
www.12voltdata.com/forum

TABLE OF CONTENTS

Installation Instructions	3
Wiring Diagram	5
Vehicle Wire Reference Chart	6
Radio Wire Reference Chart	7

INSTALLATION INSTRUCTIONS

STEP 1

- Unbox the aftermarket radio and locate its main harness.
- Connect the wires shown on the next page from aftermarket radio main harness to the VW1 T-harness and match the wire functions.

STEP 2

- Connect the factory harness to the VW1 T-harness.
- Mate the male and female 4 pin WHITE connectors of the VW1 T-harness.
- Do not use any of the RCA plugs (WHITE, GRAY, GREEN & PURPLE) of the VW1 T-harness.

STEP 3

- Access the OBDII connector located under the driver side dashboard.
- Connect the BROWN /RED wire of the VW1 T-harness to the wire located at pin 6 of the OBDII connector. (See the vehicle wire chart reference for wire colors)
- Connect the BROWN /YELLOW wire of the VW1 T-harness to the wire located at pin 14 of the OBDII connector. (See the vehicle wire chart reference for wire colors)
- Do not use the GREEN/WHITE wire.

STEP 4

- Plug the aftermarket radio harnesses into the aftermarket radio.
- Plug the Data cable to the data port of the aftermarket radio.
- Insert the Audio cable into the iDatalink 3.5 mm audio jack of the aftermarket radio.

STEP 5

- Connect all the harnesses to the Maestro RR module then proceed to module setup.

The module is now ready to be used.

Insert the aftermarket radio in the dashboard housing and test all the functionalities.

Reassemble the dashboard carefully.

Note: The OEM backup camera cannot be retained with this solution. It can be retained by using a third party component to composite video converter.

OEM BLUETOOTH SETUP

Only one Bluetooth system can be set for hands free calling. This must be determined before installation. Both the factory and aftermarket systems can be used for Bluetooth audio streaming. If the aftermarket Bluetooth is chosen for hands free calling, the aftermarket microphone must be installed in the vehicle and the factory Bluetooth module must be unplugged. In most vehicles, it is located under the passenger seat. If the vehicle is equipped with Bluetooth but there is no Bluetooth module under the passenger's seat then the Bluetooth system is built into the MDI module. Unplugging the MDI module will disable both factory systems.

2013 Kenwood Radios:

For these radio models, the OEM Bluetooth is turned OFF by default. To turn ON the OEM Bluetooth, insert the key into the ignition and turn it to the ACC position. The Radio will turn on and the setup screen will appear. Scroll to the bottom and select the vehicle set up menu by pressing SET. Go to the option OEM Bluetooth and select ON. Press the return arrow then scroll to the bottom of the page select FINISH.

2014 Kenwood Radios:

For these radio models, the OEM Bluetooth is turned ON by default. To turn OFF the OEM Bluetooth, insert the key into the ignition and turn it to the ACC position. The radio will turn ON and the setup screen will appear. Scroll to the bottom and select the vehicle set up menu by pressing SET. Go to the option OEM Bluetooth and select OFF.

2014 Alpine Radios:

For these radio models, the OEM Bluetooth is turned ON by default. To turn OFF the OEM Bluetooth, insert the key into the ignition and turn it to the ACC position. The radio will turn ON and the main screen will appear. Select the settings button, in the top right corner, then select GENERAL. Select INTEGRATION SETUP then select HANDS FREE CONNECTION. Two options will be available ON or OFF, select OFF.

INSTALLATION INSTRUCTIONS

AIRBAG WARNING LIGHT

If an airbag warning light turns ON after starting the vehicle without having the airbag light plugged in, select Clear Airbag Warning to turn OFF that warning light.

Kenwood Radios:

Main Menu>>Setup>>Sources>>Volkswagen Setup>>Vehicle Features>>Clear Airbag Warning

Alpine Radios:

Settings>>General>>Idatalink Setup>> Maestro Module>>Volkswagen Setup>>Vehicle Features>>Clear Airbag Warning

TROUBLESHOOTING TIPS:

- To reset the module back to its factory settings, turn the key to the OFF position then disconnect all connectors from the module. Press and hold the module's programming button and connect all the connectors back to the module. Wait, the module's LED will flash RED rapidly (this may take up to 10 seconds). Release the programming button. Wait, the LED will turn solid GREEN for 2 seconds.
- For technical assistance call 1-866-427-2999 or e-mail "support@idatalink.com". Visit us at "maestro.idatalink.com/support" and "www.12voltdata.com/forum/"

WIRING DIAGRAM

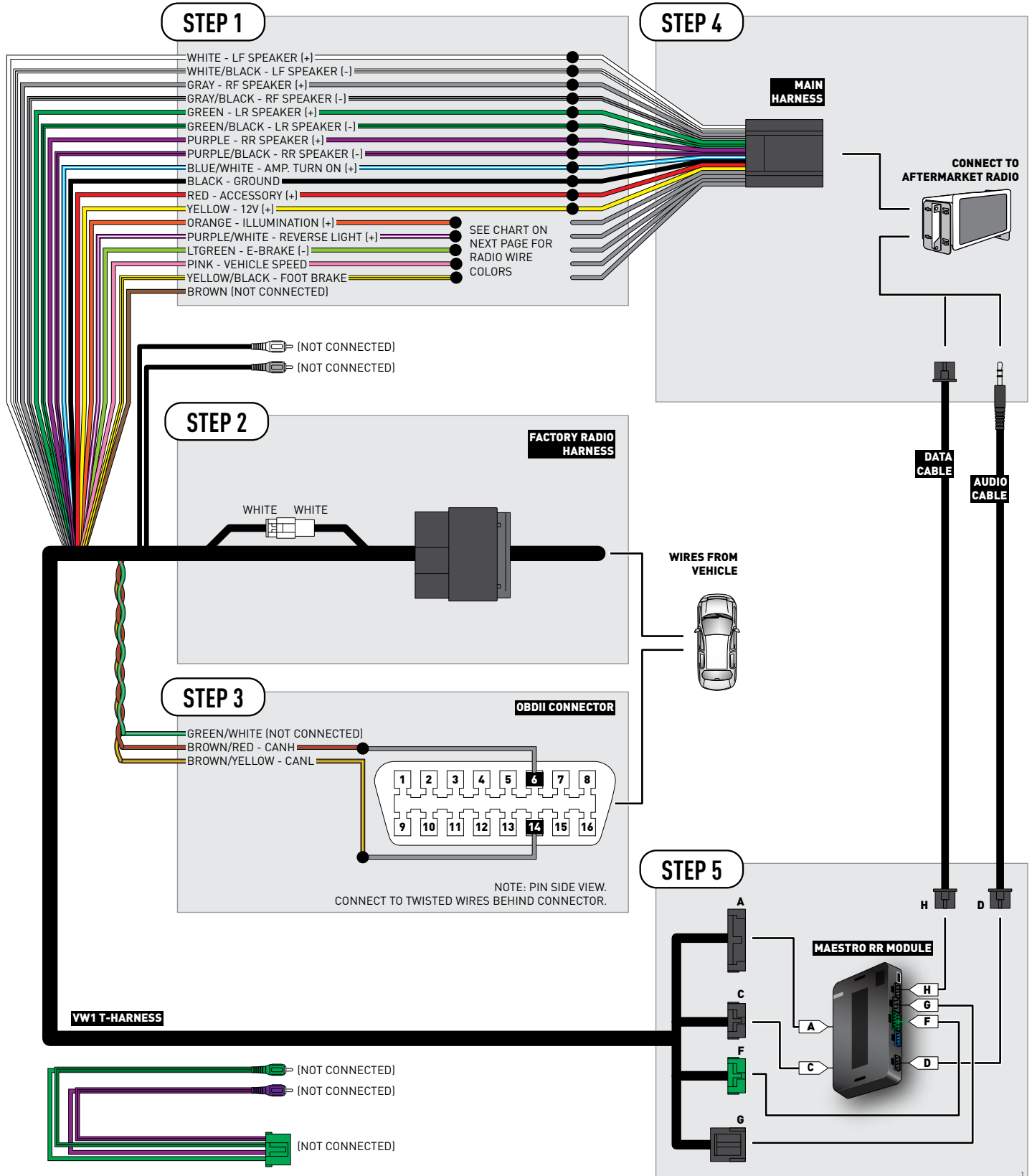

VEHICLE WIRE REFERENCE CHART

Wire Description	Connector Name	Connector Color	Connector Type	Position	Wire Color	Polarity	Wire Location
CanH	A	~	16 pin	06	Orange/Black	[DATA]	OBDII connector, under driver side dash
CanL	A	~	16 pin	14	Orange/Brown	[DATA]	OBDII connector, under driver side dash

RADIO WIRE REFERENCE CHART

Wire Description	Polarity	Wire Color on Maestro T-Harness	Wire Color on Alpine cable	Wire Color on Kenwood cable	Wire Color on Pioneer cable
Illumination	(+)	Orange	N/A	Orange/White	Orange/White
Reverse Light	(+)	Purple/White	Orange/White	Purple/White	Purple/White
E-Brake	(-)	Lt Green	Yellow/Blue	Lt Green	Lt Green
Foot Brake	(+)	Yellow/Black	Yellow/Black	N/A	N/A
VSS (vehicle speed sensor)	(DATA)	Pink	Green/White	N/A	Pink



INSTALL GUIDE VOLKSWAGEN PASSAT 2010-2015

RETAINS STEERING WHEEL CONTROLS, MFD, MDI, VW BLUETOOTH AND MORE!



PRODUCTS REQUIRED

iDatalink Maestro RR Radio Replacement Interface
iDatalink Maestro VW1 Installation Harness

OPTIONAL ACCESSORIES

None

PROGRAMMED FIRMWARE

ADS-RR(SR)-VW01-DS

NOTICE: Automotive Data Solutions Inc. (ADS) recommends having this installation performed by a certified technician. Logos and trademarks used here in are the properties of their respective owners.

WELCOME

Congratulations on the purchase of your iDatalink Maestro RR Radio replacement solution. You are now a few simple steps away from enjoying your new car radio with enhanced features.

Before starting your installation, please ensure that your iDatalink Maestro module is programmed with the correct firmware for your vehicle and that you carefully review the install guide.

Please note that Maestro RR will only retain functionalities that were originally available in the vehicle.

NEED HELP?

 **1 866 427-2999**

 support@idatalink.com

 maestro.idatalink.com/support
www.12voltdata.com/forum

TABLE OF CONTENTS

Installation Instructions	3
Wiring Diagram	5
Vehicle Wire Reference Chart	6
Radio Wire Reference Chart	7

INSTALLATION INSTRUCTIONS

STEP 1

- Unbox the aftermarket radio and locate its main harness.
- Connect the wires shown on the next page from aftermarket radio main harness to the VW1 T-harness and match the wire functions.

STEP 2

- Connect the factory harness to the VW1 T-harness.
- Mate the male and female 4 pin WHITE connectors of the VW1 T-harness.
- Do not use any of the RCA plugs (WHITE, GRAY, GREEN & PURPLE) of the VW1 T-harness.

STEP 3

- Access the OBDII connector located under the driver side dashboard.
- Connect the BROWN /RED wire of the VW1 T-harness to the wire located at pin 6 of the OBDII connector. (See the vehicle wire chart reference for wire colors)
- Connect the BROWN /YELLOW wire of the VW1 T-harness to the wire located at pin 14 of the OBDII connector. (See the vehicle wire chart reference for wire colors)
- Do not use the GREEN/WHITE wire.

STEP 4

- Plug the aftermarket radio harnesses into the aftermarket radio.
- Plug the Data cable to the data port of the aftermarket radio.
- Insert the Audio cable into the iDatalink 3.5 mm audio jack of the aftermarket radio.

STEP 5

- Connect all the harnesses to the Maestro RR module then proceed to module setup.

The module is now ready to be used.

Insert the aftermarket radio in the dashboard housing and test all the functionalities.

Reassemble the dashboard carefully.

Note: The OEM backup camera cannot be retained with this solution. It can be retained by using a third party component to composite video converter.

OEM BLUETOOTH SETUP

Only one Bluetooth system can be set for hands free calling. This must be determined before installation. Both the factory and aftermarket systems can be used for Bluetooth audio streaming. If the aftermarket Bluetooth is chosen for hands free calling, the aftermarket microphone must be installed in the vehicle and the factory Bluetooth module must be unplugged. In most vehicles, it is located under the passenger seat. If the vehicle is equipped with Bluetooth but there is no Bluetooth module under the passenger's seat then the Bluetooth system is built into the MDI module. Unplugging the MDI module will disable both factory systems.

2013 Kenwood Radios:

For these radio models, the OEM Bluetooth is turned OFF by default. To turn ON the OEM Bluetooth, insert the key into the ignition and turn it to the ACC position. The Radio will turn on and the setup screen will appear. Scroll to the bottom and select the vehicle set up menu by pressing SET. Go to the option OEM Bluetooth and select ON. Press the return arrow then scroll to the bottom of the page select FINISH.

2014 Kenwood Radios:

For these radio models, the OEM Bluetooth is turned ON by default. To turn OFF the OEM Bluetooth, insert the key into the ignition and turn it to the ACC position. The radio will turn ON and the setup screen will appear. Scroll to the bottom and select the vehicle set up menu by pressing SET. Go to the option OEM Bluetooth and select OFF.

2014 Alpine Radios:

For these radio models, the OEM Bluetooth is turned ON by default. To turn OFF the OEM Bluetooth, insert the key into the ignition and turn it to the ACC position. The radio will turn ON and the main screen will appear. Select the settings button, in the top right corner, then select GENERAL. Select INTEGRATION SETUP then select HANDS FREE CONNECTION. Two options will be available ON or OFF, select OFF.

INSTALLATION INSTRUCTIONS

AIRBAG WARNING LIGHT

If an airbag warning light turns ON after starting the vehicle without having the airbag light plugged in, select Clear Airbag Warning to turn OFF that warning light.

Kenwood Radios:

Main Menu>>Setup>>Sources>>Volkswagen Setup>>Vehicle Features>>Clear Airbag Warning

Alpine Radios:

Settings>>General>>Idatalink Setup>> Maestro Module>>Volkswagen Setup>>Vehicle Features>>Clear Airbag Warning

TROUBLESHOOTING TIPS:

- To reset the module back to its factory settings, turn the key to the OFF position then disconnect all connectors from the module. Press and hold the module's programming button and connect all the connectors back to the module. Wait, the module's LED will flash RED rapidly (this may take up to 10 seconds). Release the programming button. Wait, the LED will turn solid GREEN for 2 seconds.
- For technical assistance call 1-866-427-2999 or e-mail "support@idatalink.com". Visit us at "maestro.idatalink.com/support" and "www.12voltdata.com/forum/"

WIRING DIAGRAM

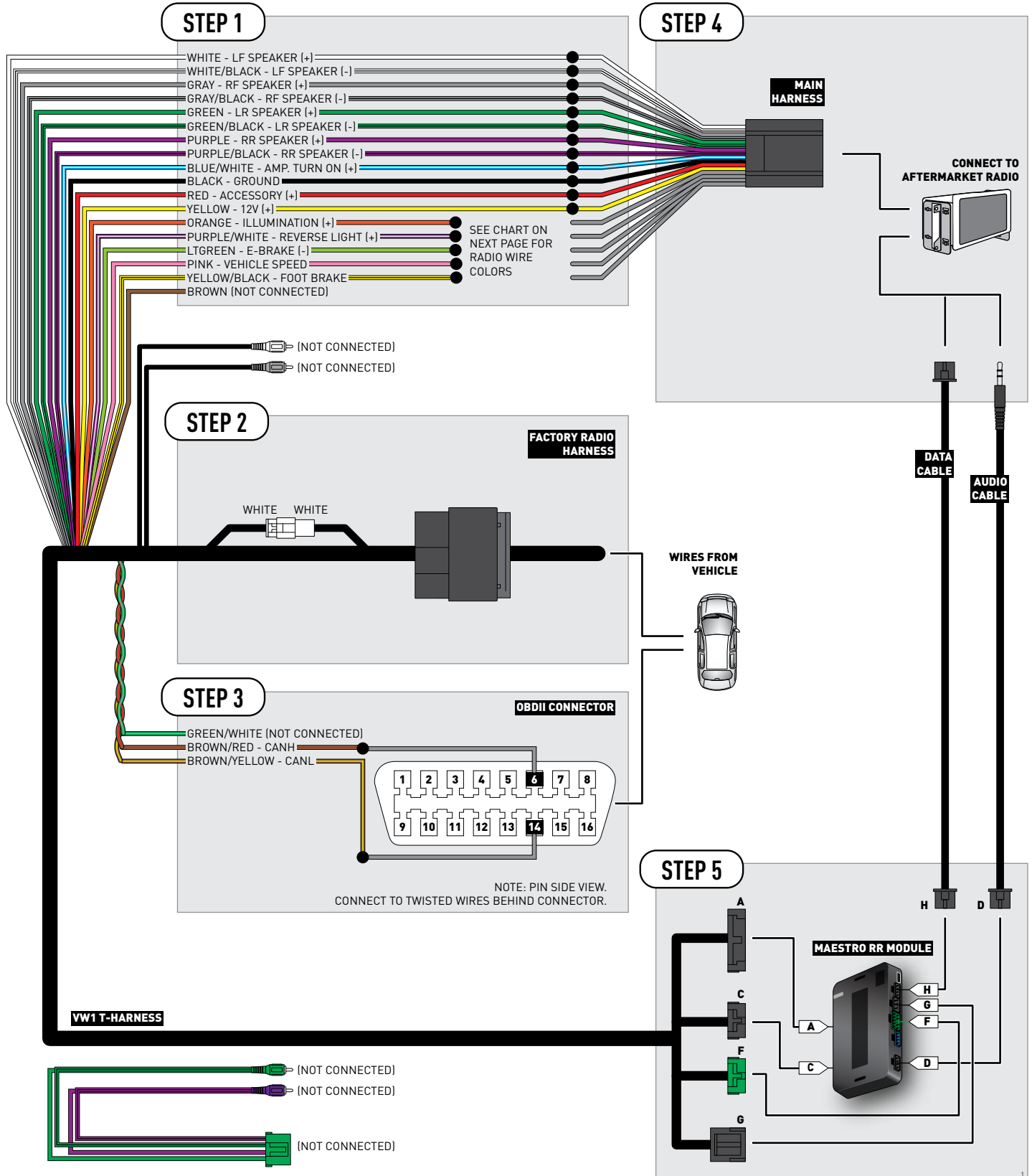

VEHICLE WIRE REFERENCE CHART

Wire Description	Connector Name	Connector Color	Connector Type	Position	Wire Color	Polarity	Wire Location
CanH	A	~	16 pin	06	Orange/Black	(DATA)	OBDII connector, under driver side dash
CanL	A	~	16 pin	14	Orange/Brown	(DATA)	OBDII connector, under driver side dash

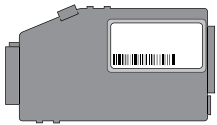

Warning: Factory Compass Module

If your vehicle is equipped with a factory compass module and you are installing an aftermarket radio that supplies navigation information to the MFD of the vehicle, disconnect the factory compass module located under the trunk Lid.

RADIO WIRE REFERENCE CHART

Wire Description	Polarity	Wire Color on Maestro T-Harness	Wire Color on Alpine cable	Wire Color on Kenwood cable	Wire Color on Pioneer cable
Illumination	(+)	Orange	N/A	Orange/White	Orange/White
Reverse Light	(+)	Purple/White	Orange/White	Purple/White	Purple/White
E-Brake	(-)	Lt Green	Yellow/Blue	Lt Green	Lt Green
Foot Brake	(+)	Yellow/Black	Yellow/Black	N/A	N/A
VSS (vehicle speed sensor)	(DATA)	Pink	Green/White	N/A	Pink



INSTALL GUIDE VOLKSWAGEN RABBIT 2006-2009

RETAINS STEERING WHEEL CONTROLS, MFD, MDI, VW BLUETOOTH AND MORE!



PRODUCTS REQUIRED

iDatalink Maestro RR Radio Replacement Interface
iDatalink Maestro VW1 Installation Harness

OPTIONAL ACCESSORIES

None

PROGRAMMED FIRMWARE

ADS-RR(SR)-VW01-DS

NOTICE: Automotive Data Solutions Inc. (ADS) recommends having this installation performed by a certified technician. Logos and trademarks used here in are the properties of their respective owners.

WELCOME

Congratulations on the purchase of your iDatalink Maestro RR Radio replacement solution. You are now a few simple steps away from enjoying your new car radio with enhanced features.

Before starting your installation, please ensure that your iDatalink Maestro module is programmed with the correct firmware for your vehicle and that you carefully review the install guide.

Please note that Maestro RR will only retain functionalities that were originally available in the vehicle.

NEED HELP?

 **1 866 427-2999**

 support@idatalink.com

 maestro.idatalink.com/support
www.12voltdata.com/forum

TABLE OF CONTENTS

Installation Instructions	3
Wiring Diagram	5
Vehicle Wire Reference Chart	6
Radio Wire Reference Chart	7

INSTALLATION INSTRUCTIONS

STEP 1

- Unbox the aftermarket radio and locate its main harness.
- Connect the wires shown on the next page from aftermarket radio main harness to the VW1 T-harness and match the wire functions.

STEP 2

- Connect the factory harness to the VW1 T-harness.
- Mate the male and female 4 pin WHITE connectors of the VW1 T-harness.
- Do not use any of the RCA plugs (WHITE, GRAY, GREEN & PURPLE) of the VW1 T-harness.

STEP 3

- Access the OBDII connector located under the driver side dashboard.
- Connect the BROWN /RED wire of the VW1 T-harness to the wire located at pin 6 of the OBDII connector. (See the vehicle wire chart reference for wire colors)
- Connect the BROWN /YELLOW wire of the VW1 T-harness to the wire located at pin 14 of the OBDII connector. (See the vehicle wire chart reference for wire colors)
- Do not use the GREEN/WHITE wire.

STEP 4

- Plug the aftermarket radio harnesses into the aftermarket radio.
- Plug the Data cable to the data port of the aftermarket radio.
- Insert the Audio cable into the iDatalink 3.5 mm audio jack of the aftermarket radio.

STEP 5

- Connect all the harnesses to the Maestro RR module then proceed to module setup.

The module is now ready to be used.

Insert the aftermarket radio in the dashboard housing and test all the functionalities.

Reassemble the dashboard carefully.

Note: The OEM backup camera cannot be retained with this solution. It can be retained by using a third party component to composite video converter.

OEM BLUETOOTH SETUP

Only one Bluetooth system can be set for hands free calling. This must be determined before installation. Both the factory and aftermarket systems can be used for Bluetooth audio streaming. If the aftermarket Bluetooth is chosen for hands free calling, the aftermarket microphone must be installed in the vehicle and the factory Bluetooth module must be unplugged. In most vehicles, it is located under the passenger seat. If the vehicle is equipped with Bluetooth but there is no Bluetooth module under the passenger's seat then the Bluetooth system is built into the MDI module. Unplugging the MDI module will disable both factory systems.

2013 Kenwood Radios:

For these radio models, the OEM Bluetooth is turned OFF by default. To turn ON the OEM Bluetooth, insert the key into the ignition and turn it to the ACC position. The Radio will turn on and the setup screen will appear. Scroll to the bottom and select the vehicle set up menu by pressing SET. Go to the option OEM Bluetooth and select ON. Press the return arrow then scroll to the bottom of the page select FINISH.

2014 Kenwood Radios:

For these radio models, the OEM Bluetooth is turned ON by default. To turn OFF the OEM Bluetooth, insert the key into the ignition and turn it to the ACC position. The radio will turn ON and the setup screen will appear. Scroll to the bottom and select the vehicle set up menu by pressing SET. Go to the option OEM Bluetooth and select OFF.

2014 Alpine Radios:

For these radio models, the OEM Bluetooth is turned ON by default. To turn OFF the OEM Bluetooth, insert the key into the ignition and turn it to the ACC position. The radio will turn ON and the main screen will appear. Select the settings button, in the top right corner, then select GENERAL. Select INTEGRATION SETUP then select HANDS FREE CONNECTION. Two options will be available ON or OFF, select OFF.

INSTALLATION INSTRUCTIONS

AIRBAG WARNING LIGHT

If an airbag warning light turns ON after starting the vehicle without having the airbag light plugged in, select Clear Airbag Warning to turn OFF that warning light.

Kenwood Radios:

Main Menu>>Setup>>Sources>>Volkswagen Setup>>Vehicle Features>>Clear Airbag Warning

Alpine Radios:

Settings>>General>>Idatalink Setup>> Maestro Module>>Volkswagen Setup>>Vehicle Features>>Clear Airbag Warning

TROUBLESHOOTING TIPS:

- To reset the module back to its factory settings, turn the key to the OFF position then disconnect all connectors from the module. Press and hold the module's programming button and connect all the connectors back to the module. Wait, the module's LED will flash RED rapidly (this may take up to 10 seconds). Release the programming button. Wait, the LED will turn solid GREEN for 2 seconds.
- For technical assistance call 1-866-427-2999 or e-mail "support@idatalink.com". Visit us at "maestro.idatalink.com/support" and "www.12voldata.com/forum/"

WIRING DIAGRAM

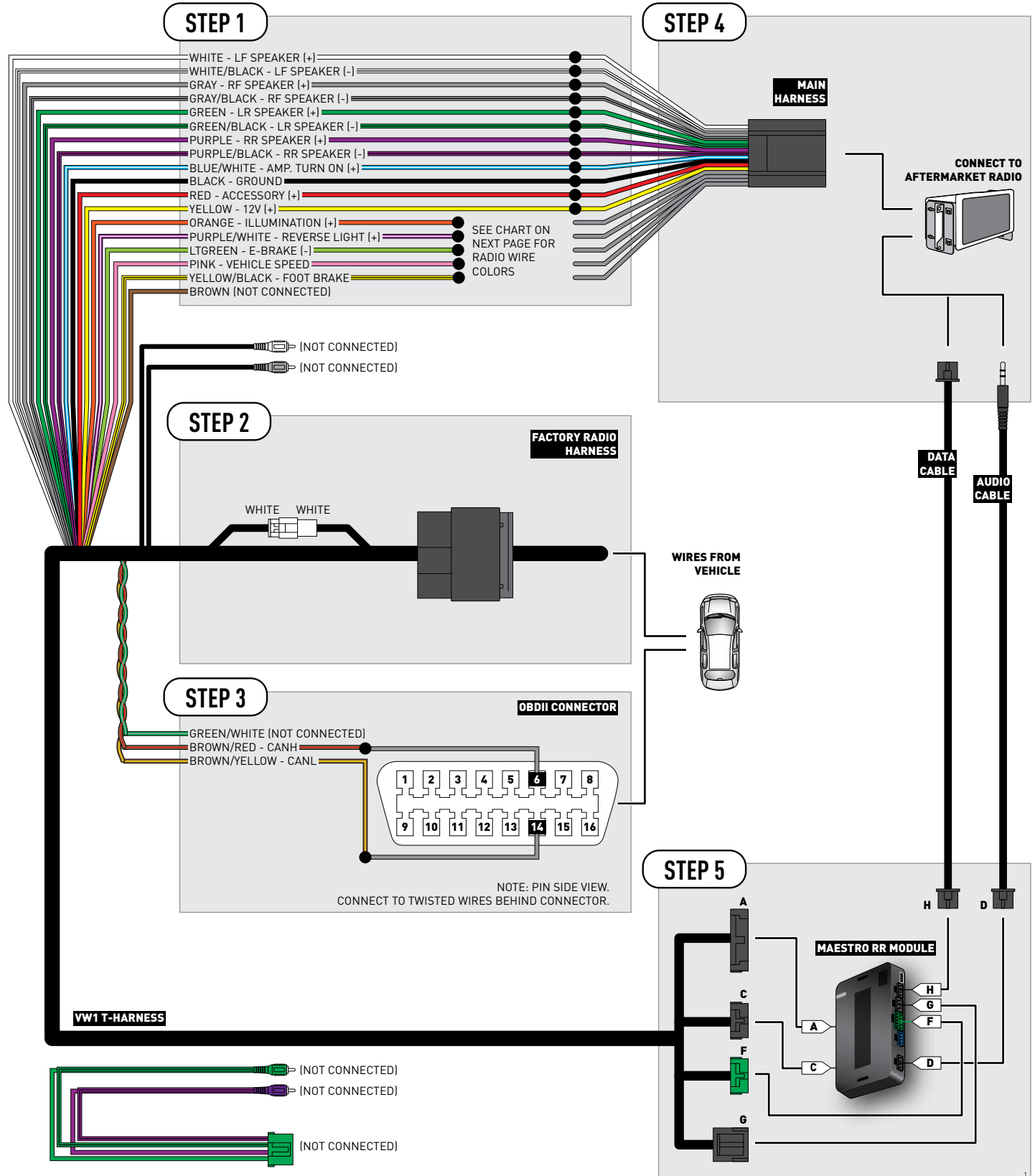

VEHICLE WIRE REFERENCE CHART

Wire Description	Connector Name	Connector Color	Connector Type	Position	Wire Color	Polarity	Wire Location
CanH	A	~	16 pin	06	Orange/Black	(DATA)	OBDII connector, under driver side dash
CanL	A	~	16 pin	14	Orange/Brown	(DATA)	OBDII connector, under driver side dash

RADIO WIRE REFERENCE CHART

Wire Description	Polarity	Wire Color on Maestro T-Harness	Wire Color on Alpine cable	Wire Color on Kenwood cable	Wire Color on Pioneer cable
Illumination	(+)	Orange	N/A	Orange/White	Orange/White
Reverse Light	(+)	Purple/White	Orange/White	Purple/White	Purple/White
E-Brake	(-)	Lt Green	Yellow/Blue	Lt Green	Lt Green
Foot Brake	(+)	Yellow/Black	Yellow/Black	N/A	N/A
VSS (vehicle speed sensor)	(DATA)	Pink	Green/White	N/A	Pink



INSTALL GUIDE VOLKSWAGEN TIGUAN 2009

RETAINS STEERING WHEEL CONTROLS, MFD, MDI, VW BLUETOOTH AND MORE!



PRODUCTS REQUIRED

iDatalink Maestro RR Radio Replacement Interface
iDatalink Maestro VW1 Installation Harness

OPTIONAL ACCESSORIES

None

PROGRAMMED FIRMWARE

ADS-RR(SR)-VW01-DS

NOTICE: Automotive Data Solutions Inc. (ADS) recommends having this installation performed by a certified technician. Logos and trademarks used here in are the properties of their respective owners.

WELCOME

Congratulations on the purchase of your iDatalink Maestro RR Radio replacement solution. You are now a few simple steps away from enjoying your new car radio with enhanced features.

Before starting your installation, please ensure that your iDatalink Maestro module is programmed with the correct firmware for your vehicle and that you carefully review the install guide.

Please note that Maestro RR will only retain functionalities that were originally available in the vehicle.

NEED HELP?

 **1 866 427-2999**

 support@idatalink.com

 maestro.idatalink.com/support
www.12voltdata.com/forum

TABLE OF CONTENTS

Installation Instructions	3
Wiring Diagram	5
Vehicle Wire Reference Chart	6
Radio Wire Reference Chart	7

INSTALLATION INSTRUCTIONS

STEP 1

- Unbox the aftermarket radio and locate its main harness.
- Connect the wires shown on the next page from aftermarket radio main harness to the VW1 T-harness and match the wire functions.

STEP 2

- Connect the factory harness to the VW1 T-harness.
- Mate the male and female 4 pin WHITE connectors of the VW1 T-harness.
- Do not use any of the RCA plugs (WHITE, GRAY, GREEN & PURPLE) of the VW1 T-harness.

STEP 3

- Access the OBDII connector located under the driver side dashboard.
- Connect the BROWN /RED wire of the VW1 T-harness to the wire located at pin 6 of the OBDII connector. (See the vehicle wire chart reference for wire colors)
- Connect the BROWN /YELLOW wire of the VW1 T-harness to the wire located at pin 14 of the OBDII connector. (See the vehicle wire chart reference for wire colors)
- Do not use the GREEN/WHITE wire.

STEP 4

- Plug the aftermarket radio harnesses into the aftermarket radio.
- Plug the Data cable to the data port of the aftermarket radio.
- Insert the Audio cable into the iDatalink 3.5 mm audio jack of the aftermarket radio.

STEP 5

- Connect all the harnesses to the Maestro RR module then proceed to module setup.

The module is now ready to be used.

Insert the aftermarket radio in the dashboard housing and test all the functionalities.

Reassemble the dashboard carefully.

Note: The OEM backup camera cannot be retained with this solution. It can be retained by using a third party component to composite video converter.

OEM BLUETOOTH SETUP

Only one Bluetooth system can be set for hands free calling. This must be determined before installation. Both the factory and aftermarket systems can be used for Bluetooth audio streaming. If the aftermarket Bluetooth is chosen for hands free calling, the aftermarket microphone must be installed in the vehicle and the factory Bluetooth module must be unplugged. In most vehicles, it is located under the passenger seat. If the vehicle is equipped with Bluetooth but there is no Bluetooth module under the passenger's seat then the Bluetooth system is built into the MDI module. Unplugging the MDI module will disable both factory systems.

2013 Kenwood Radios:

For these radio models, the OEM Bluetooth is turned OFF by default. To turn ON the OEM Bluetooth, insert the key into the ignition and turn it to the ACC position. The Radio will turn on and the setup screen will appear. Scroll to the bottom and select the vehicle set up menu by pressing SET. Go to the option OEM Bluetooth and select ON. Press the return arrow then scroll to the bottom of the page select FINISH.

2014 Kenwood Radios:

For these radio models, the OEM Bluetooth is turned ON by default. To turn OFF the OEM Bluetooth, insert the key into the ignition and turn it to the ACC position. The radio will turn ON and the setup screen will appear. Scroll to the bottom and select the vehicle set up menu by pressing SET. Go to the option OEM Bluetooth and select OFF.

2014 Alpine Radios:

For these radio models, the OEM Bluetooth is turned ON by default. To turn OFF the OEM Bluetooth, insert the key into the ignition and turn it to the ACC position. The radio will turn ON and the main screen will appear. Select the settings button, in the top right corner, then select GENERAL. Select INTEGRATION SETUP then select HANDS FREE CONNECTION. Two options will be available ON or OFF, select OFF.

INSTALLATION INSTRUCTIONS

AIRBAG WARNING LIGHT

If an airbag warning light turns ON after starting the vehicle without having the airbag light plugged in, select Clear Airbag Warning to turn OFF that warning light.

Kenwood Radios:

Main Menu>>Setup>>Sources>>Volkswagen Setup>>Vehicle Features>>Clear Airbag Warning

Alpine Radios:

Settings>>General>>Idatalink Setup>> Maestro Module>>Volkswagen Setup>>Vehicle Features>>Clear Airbag Warning

TROUBLESHOOTING TIPS:

- To reset the module back to its factory settings, turn the key to the OFF position then disconnect all connectors from the module. Press and hold the module's programming button and connect all the connectors back to the module. Wait, the module's LED will flash RED rapidly (this may take up to 10 seconds). Release the programming button. Wait, the LED will turn solid GREEN for 2 seconds.
- For technical assistance call 1-866-427-2999 or e-mail "support@idatalink.com". Visit us at "maestro.idatalink.com/support" and "www.12voltdata.com/forum/"

WIRING DIAGRAM

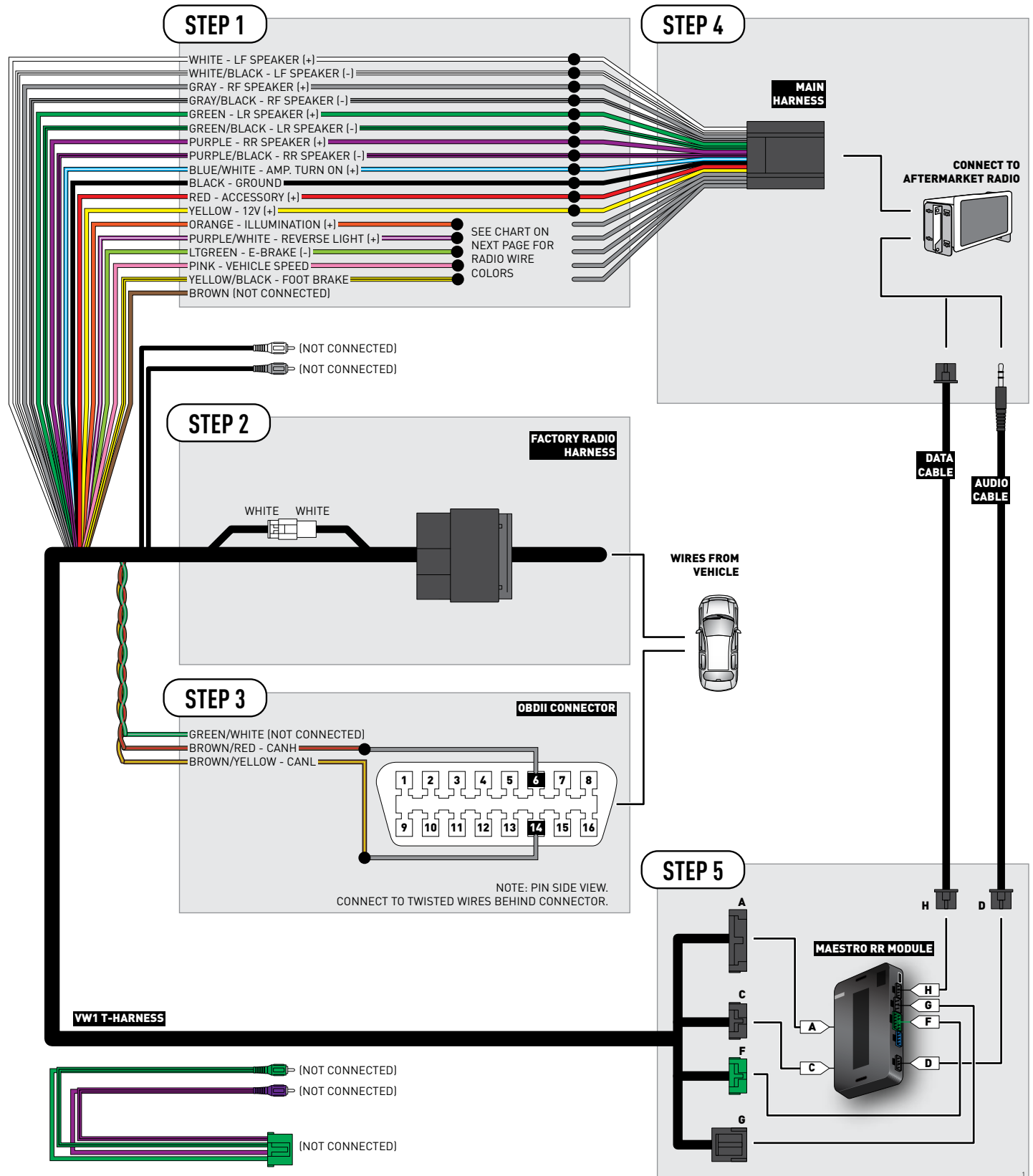

VEHICLE WIRE REFERENCE CHART

Wire Description	Connector Name	Connector Color	Connector Type	Position	Wire Color	Polarity	Wire Location
CanH	A	~	16 pin	06	Orange/Black	(DATA)	OBDII connector, under driver side dash
CanL	A	~	16 pin	14	Orange/Brown	(DATA)	OBDII connector, under driver side dash

RADIO WIRE REFERENCE CHART

Wire Description	Polarity	Wire Color on Maestro T-Harness	Wire Color on Alpine cable	Wire Color on Kenwood cable	Wire Color on Pioneer cable
Illumination	(+)	Orange	N/A	Orange/White	Orange/White
Reverse Light	(+)	Purple/White	Orange/White	Purple/White	Purple/White
E-Brake	(-)	Lt Green	Yellow/Blue	Lt Green	Lt Green
Foot Brake	(+)	Yellow/Black	Yellow/Black	N/A	N/A
VSS (vehicle speed sensor)	(DATA)	Pink	Green/White	N/A	Pink



INSTALL GUIDE VOLKSWAGEN TIGUAN 2010-2015

RETAINS STEERING WHEEL CONTROLS, MFD, MDI, VW BLUETOOTH AND MORE!



PRODUCTS REQUIRED

iDatalink Maestro RR Radio Replacement Interface
iDatalink Maestro VW1 Installation Harness

OPTIONAL ACCESSORIES

None

PROGRAMMED FIRMWARE

ADS-RR(SR)-VW01-DS

NOTICE: Automotive Data Solutions Inc. (ADS) recommends having this installation performed by a certified technician. Logos and trademarks used here in are the properties of their respective owners.

WELCOME

Congratulations on the purchase of your iDatalink Maestro RR Radio replacement solution. You are now a few simple steps away from enjoying your new car radio with enhanced features.

Before starting your installation, please ensure that your iDatalink Maestro module is programmed with the correct firmware for your vehicle and that you carefully review the install guide.

Please note that Maestro RR will only retain functionalities that were originally available in the vehicle.

NEED HELP?

 **1 866 427-2999**

 support@idatalink.com

 maestro.idatalink.com/support
www.12voltdata.com/forum

TABLE OF CONTENTS

Installation Instructions	3
Wiring Diagram	5
Vehicle Wire Reference Chart	6
Radio Wire Reference Chart	7

INSTALLATION INSTRUCTIONS

STEP 1

- Unbox the aftermarket radio and locate its main harness.
- Connect the wires shown on the next page from aftermarket radio main harness to the VW1 T-harness and match the wire functions.

STEP 2

- Connect the factory harness to the VW1 T-harness.
- Mate the male and female 4 pin WHITE connectors of the VW1 T-harness.
- Do not use any of the RCA plugs (WHITE, GRAY, GREEN & PURPLE) of the VW1 T-harness.

STEP 3

- Access the OBDII connector located under the driver side dashboard.
- Connect the BROWN /RED wire of the VW1 T-harness to the wire located at pin 6 of the OBDII connector. (See the vehicle wire chart reference for wire colors)
- Connect the BROWN /YELLOW wire of the VW1 T-harness to the wire located at pin 14 of the OBDII connector. (See the vehicle wire chart reference for wire colors)
- Do not use the GREEN/WHITE wire.

STEP 4

- Plug the aftermarket radio harnesses into the aftermarket radio.
- Plug the Data cable to the data port of the aftermarket radio.
- Insert the Audio cable into the iDatalink 3.5 mm audio jack of the aftermarket radio.

STEP 5

- Connect all the harnesses to the Maestro RR module then proceed to module setup.

The module is now ready to be used.

Insert the aftermarket radio in the dashboard housing and test all the functionalities.

Reassemble the dashboard carefully.

Note: The OEM backup camera cannot be retained with this solution. It can be retained by using a third party component to composite video converter.

OEM BLUETOOTH SETUP

Only one Bluetooth system can be set for hands free calling. This must be determined before installation. Both the factory and aftermarket systems can be used for Bluetooth audio streaming. If the aftermarket Bluetooth is chosen for hands free calling, the aftermarket microphone must be installed in the vehicle and the factory Bluetooth module must be unplugged. In most vehicles, it is located under the passenger seat. If the vehicle is equipped with Bluetooth but there is no Bluetooth module under the passenger's seat then the Bluetooth system is built into the MDI module. Unplugging the MDI module will disable both factory systems.

2013 Kenwood Radios:

For these radio models, the OEM Bluetooth is turned OFF by default. To turn ON the OEM Bluetooth, insert the key into the ignition and turn it to the ACC position. The Radio will turn on and the setup screen will appear. Scroll to the bottom and select the vehicle set up menu by pressing SET. Go to the option OEM Bluetooth and select ON. Press the return arrow then scroll to the bottom of the page select FINISH.

2014 Kenwood Radios:

For these radio models, the OEM Bluetooth is turned ON by default. To turn OFF the OEM Bluetooth, insert the key into the ignition and turn it to the ACC position. The radio will turn ON and the setup screen will appear. Scroll to the bottom and select the vehicle set up menu by pressing SET. Go to the option OEM Bluetooth and select OFF.

2014 Alpine Radios:

For these radio models, the OEM Bluetooth is turned ON by default. To turn OFF the OEM Bluetooth, insert the key into the ignition and turn it to the ACC position. The radio will turn ON and the main screen will appear. Select the settings button, in the top right corner, then select GENERAL. Select INTEGRATION SETUP then select HANDS FREE CONNECTION. Two options will be available ON or OFF, select OFF.

INSTALLATION INSTRUCTIONS

AIRBAG WARNING LIGHT

If an airbag warning light turns ON after starting the vehicle without having the airbag light plugged in, select Clear Airbag Warning to turn OFF that warning light.

Kenwood Radios:

Main Menu>>Setup>>Sources>>Volkswagen Setup>>Vehicle Features>>Clear Airbag Warning

Alpine Radios:

Settings>>General>>Idatalink Setup>> Maestro Module>>Volkswagen Setup>>Vehicle Features>>Clear Airbag Warning

TROUBLESHOOTING TIPS:

- To reset the module back to its factory settings, turn the key to the OFF position then disconnect all connectors from the module. Press and hold the module's programming button and connect all the connectors back to the module. Wait, the module's LED will flash RED rapidly (this may take up to 10 seconds). Release the programming button. Wait, the LED will turn solid GREEN for 2 seconds.
- For technical assistance call 1-866-427-2999 or e-mail "support@idatalink.com". Visit us at "maestro.idatalink.com/support" and "www.12voldata.com/forum/"

WIRING DIAGRAM

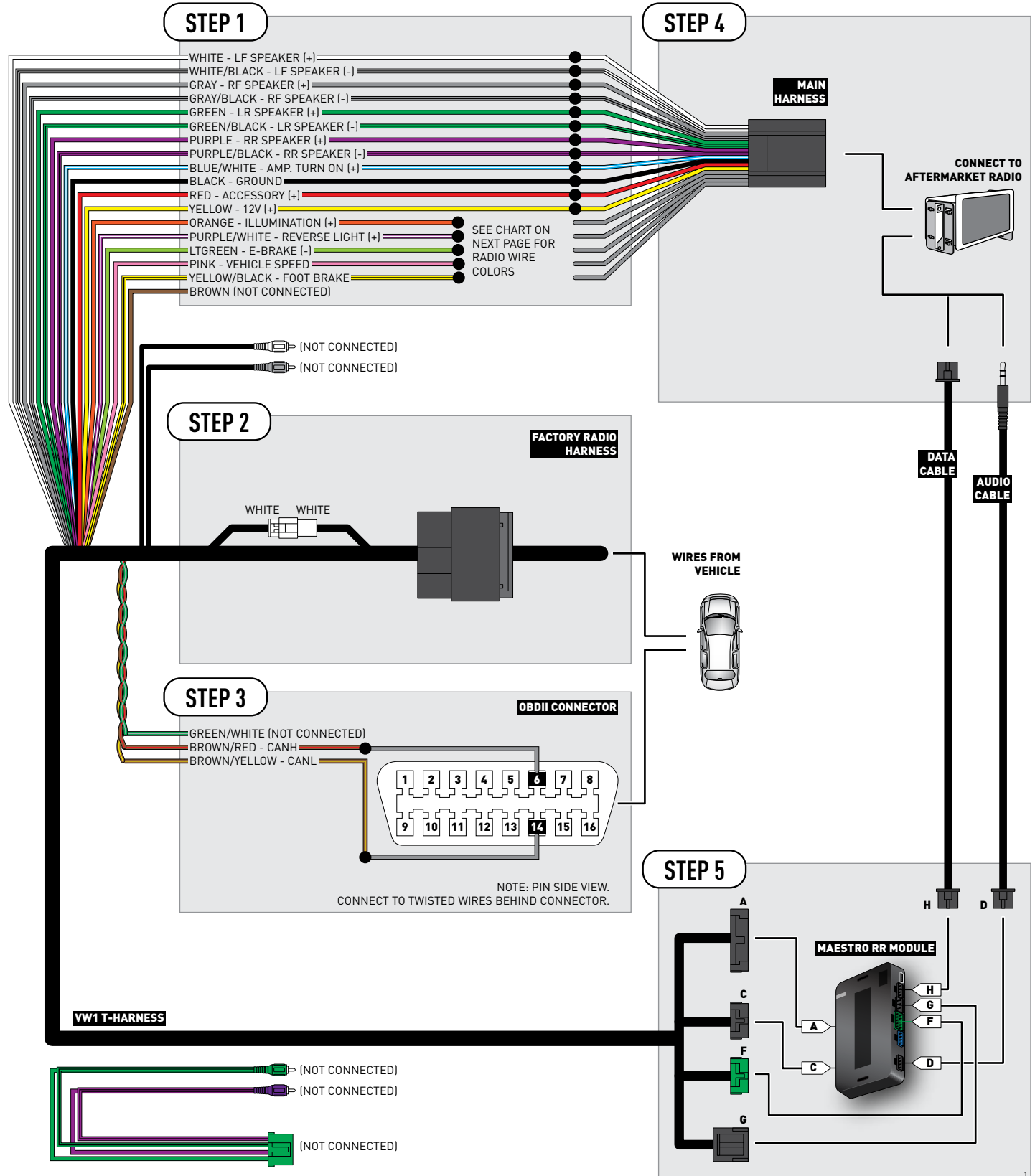

VEHICLE WIRE REFERENCE CHART

Wire Description	Connector Name	Connector Color	Connector Type	Position	Wire Color	Polarity	Wire Location
CanH	A	~	16 pin	06	Orange/Black	(DATA)	OBDII connector, under driver side dash
CanL	A	~	16 pin	14	Orange/Brown	(DATA)	OBDII connector, under driver side dash

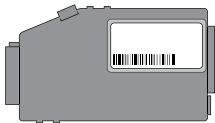

Warning: Factory Compass Module

If your vehicle is equipped with a factory compass module and you are installing an aftermarket radio that supplies navigation information to the MFD of the vehicle, disconnect the factory compass module located under the headliner at the rear of the vehicle.

RADIO WIRE REFERENCE CHART

Wire Description	Polarity	Wire Color on Maestro T-Harness	Wire Color on Alpine cable	Wire Color on Kenwood cable	Wire Color on Pioneer cable
Illumination	(+)	Orange	N/A	Orange/White	Orange/White
Reverse Light	(+)	Purple/White	Orange/White	Purple/White	Purple/White
E-Brake	(-)	Lt Green	Yellow/Blue	Lt Green	Lt Green
Foot Brake	(+)	Yellow/Black	Yellow/Black	N/A	N/A
VSS (vehicle speed sensor)	(DATA)	Pink	Green/White	N/A	Pink