



HOW TO USE THIS INSTALL GUIDE

- 1** Open the Bookmarks menu and find your vehicle OR scroll down until you find the install guide for your vehicle.
- 2** Print only the pages for your vehicle using the advanced options in the Print menu.
- 3** Install your DSR1 module according to the guide for your vehicle.

WARNING

Pressing the printer icon or "quick printing" this document will print all of the guides in this compilation.



INSTALL GUIDE TOYOTA 4 RUNNER WITH JBL 2014-2018

RETAINS FACTORY AMPLIFIER, STEERING WHEEL CONTROLS, AND MORE!



PRODUCTS REQUIRED

iDatalink Maestro RR Radio Replacement Interface
iDatalink Maestro T02 Installation Harness

OPTIONAL ACCESSORIES

PROGRAMMED FIRMWARE

ADS-RR(SR)-TOY02-DS

NOTICE: Automotive Data Solutions Inc. (ADS) recommends having this installation performed by a certified technician. Logos and trademarks used here in are the properties of their respective owners.

WELCOME

Congratulations on the purchase of your iDatalink Maestro RR Radio replacement solution. You are now a few simple steps away from enjoying your new car radio with enhanced features.

Before starting your installation, please ensure that your iDatalink Maestro module is programmed with the correct firmware and that you carefully review the Installation Diagram and Vehicle Wire Reference Chart.

Please note that Maestro RR will only retain functionalities that were originally available in the vehicle.

NEED HELP?

 **1 866 427-2999**

 **support@idatalink.com**

 **maestro.idatalink.com/support
www.12voltdata.com/forum**

DURING INSTALLATION

Installation Instructions	3
Wiring Diagram	4
Radio Wire Reference Chart	5

INSTALLATION INSTRUCTIONS

STEP 1

- Unbox the aftermarket radio and locate its main harness.
- Connect the wires shown on the next page from aftermarket radio main harness to the T02 T-harness and match the wire functions.
- Remove the factory radio.

STEP 2

- If the vehicle is equipped with an OEM backup camera, connect the T02 T-harness to the backup camera harness.

STEP 3

- Connect the factory harness to the T02 T-harness.

STEP 4

- Plug the male WHITE 2 pin connector of your T02 T-harness into the OBDII harness.
- Plug the OBDII connector into the OBDII of the vehicle.

STEP 5

- Plug the aftermarket radio harnesses into the aftermarket radio.
- Connect the backup camera RCA cable into the aftermarket radio (if equipped).
- Connect the auxiliary RCA cables into the aftermarket radio (if equipped).
- Plug the Data cable to the data port of the aftermarket radio.

STEP 6

- Connect all the harnesses to the Maestro RR module then test your installation.

TROUBLESHOOTING TIPS:

- To reset the module back its factory settings, turn the key to the OFF position then disconnect all connectors from the module. Press and hold the module's programming button and connect all the connectors back to the module. Wait, the module's LED will flash RED rapidly (this may take up to 10 seconds). Release the programming button. Wait, the LED will turn solid GREEN for 2 seconds.
- For technical assistance call 1-866-427-2999 or e-mail "support@idatalink.com". Visit us at "maestro.idatalink.com/support" and "www.12voltdata.com/forum/"

WIRING DIAGRAM *with an Amplifier*

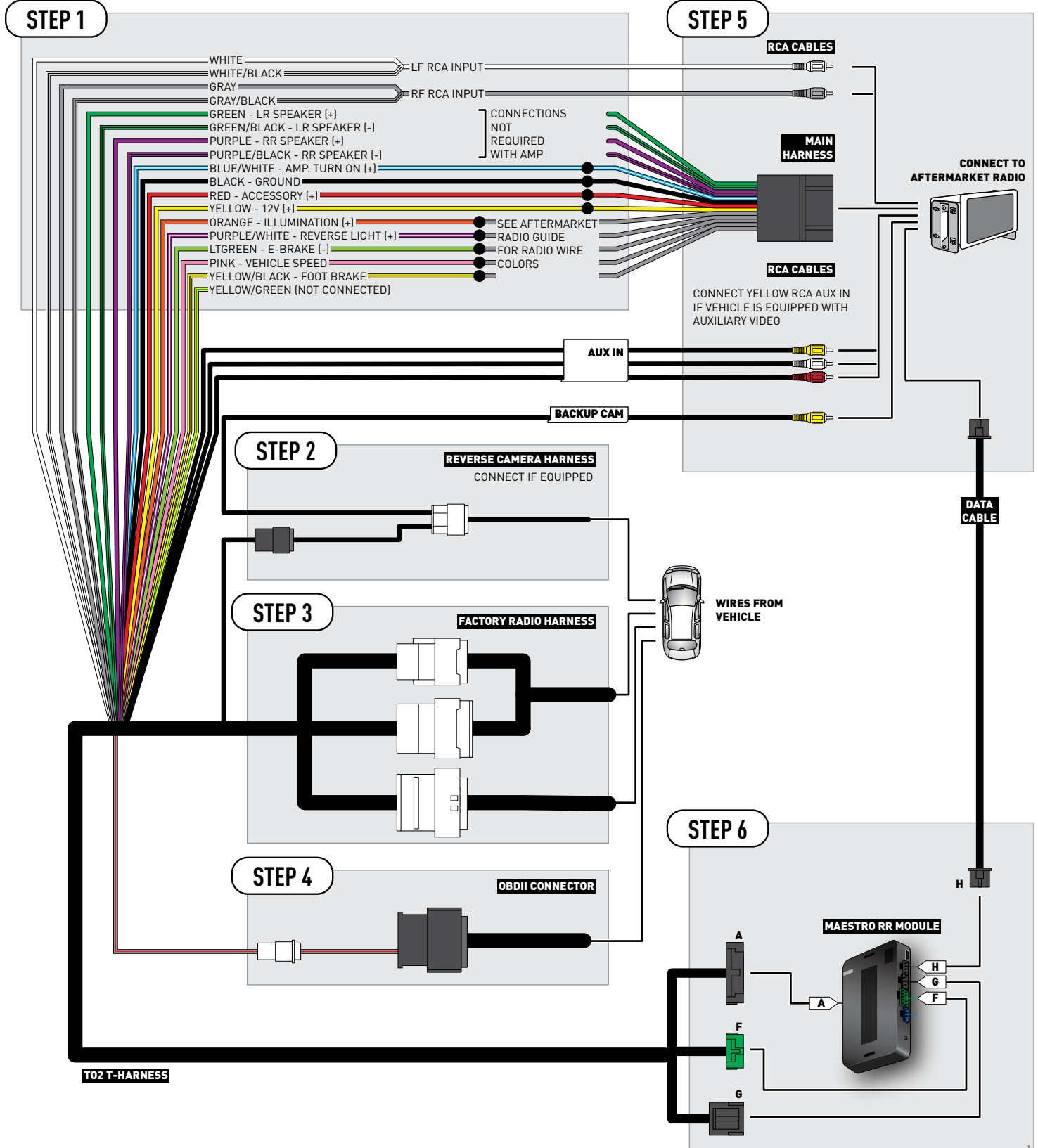

RADIO WIRE REFERENCE CHART

Wire Description	Polarity	Wire Color on Maestro T-Harness	Wire Color on Alpine cable	Wire Color on Kenwood cable	Wire Color on Pioneer cable
Illumination	(+)	Orange	N/A	Orange/White	Orange/White
Reverse Light	(+)	Purple/White or Yellow/Green (see Wiring diagram)	Orange/White	Purple/White	Purple/White
E-Brake	(-)	Lt Green	Yellow/Blue	Lt Green	Lt Green
Foot Brake	(+)	Yellow/Black	Yellow/Black	N/A	N/A
VSS (vehicle speed sensor)	(DATA)	Pink	Green/White	N/A	Pink



INSTALL GUIDE TOYOTA 4 RUNNER WITHOUT JBL 2014-2018

RETAINS FACTORY AMPLIFIER, STEERING WHEEL CONTROLS, AND MORE!



PRODUCTS REQUIRED

iDatalink Maestro RR Radio Replacement Interface
iDatalink Maestro T02 Installation Harness

OPTIONAL ACCESSORIES

PROGRAMMED FIRMWARE

ADS-RR(SR)-TOY02-DS

NOTICE: Automotive Data Solutions Inc. (ADS) recommends having this installation performed by a certified technician. Logos and trademarks used here in are the properties of their respective owners.

WELCOME

Congratulations on the purchase of your iDatalink Maestro RR Radio replacement solution. You are now a few simple steps away from enjoying your new car radio with enhanced features.

Before starting your installation, please ensure that your iDatalink Maestro module is programmed with the correct firmware and that you carefully review the Installation Diagram and Vehicle Wire Reference Chart.

Please note that Maestro RR will only retain functionalities that were originally available in the vehicle.

NEED HELP?

 **1 866 427-2999**

 **support@idatalink.com**

 **maestro.idatalink.com/support
www.12voltdata.com/forum**

DURING INSTALLATION

Installation Instructions	3
Wiring Diagram	4
Radio Wire Reference Chart	5

INSTALLATION INSTRUCTIONS

STEP 1

- Unbox the aftermarket radio and locate its main harness.
- Cut and remove the front speaker wire junction connectors.
- Connect the wires shown on the next page from aftermarket radio main harness to the T02 T-harness and match the wire functions.
- Remove the factory radio.

STEP 2

- If the vehicle is equipped with an OEM backup camera, connect the T02 T-harness to the backup camera harness.

STEP 3

- Connect the factory harness to the T02 T-harness.

STEP 4

- Plug the male WHITE 2 pin connector of your T02 T-harness into the OBDII harness.
- Plug the OBDII connector into the OBDII of the vehicle.

STEP 5

- Plug the aftermarket radio harnesses into the aftermarket radio.
- Connect the backup camera RCA cable into the aftermarket radio (if equipped).
- Connect the auxiliary RCA cables into the aftermarket radio (if equipped).
- Plug the Data cable to the data port of the aftermarket radio.

STEP 6

- Connect all the harnesses to the Maestro RR module then test your installation.

TROUBLESHOOTING TIPS:

- To reset the module back its factory settings, turn the key to the OFF position then disconnect all connectors from the module. Press and hold the module's programming button and connect all the connectors back to the module. Wait, the module's LED will flash RED rapidly (this may take up to 10 seconds). Release the programming button. Wait, the LED will turn solid GREEN for 2 seconds.
- For technical assistance call 1-866-427-2999 or e-mail "support@idatalink.com". Visit us at "maestro.idatalink.com/support" and "www.12voltdata.com/forum/"

WIRING DIAGRAM *without an Amplifier*

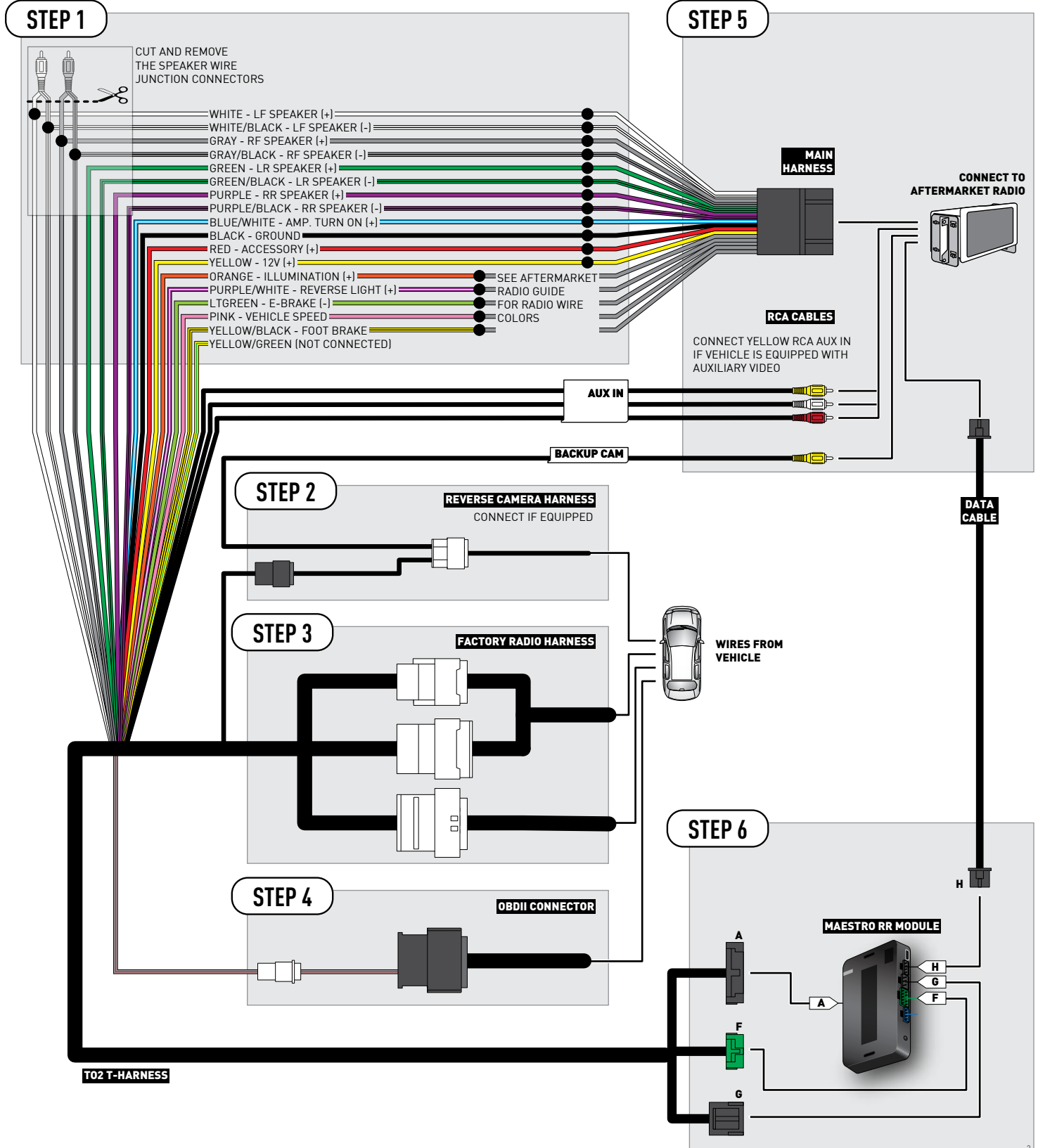

RADIO WIRE REFERENCE CHART

Wire Description	Polarity	Wire Color on Maestro T-Harness	Wire Color on Alpine cable	Wire Color on Kenwood cable	Wire Color on Pioneer cable
Illumination	(+)	Orange	N/A	Orange/White	Orange/White
Reverse Light	(+)	Purple/White or Yellow/Green (see Wiring diagram)	Orange/White	Purple/White	Purple/White
E-Brake	(-)	Lt Green	Yellow/Blue	Lt Green	Lt Green
Foot Brake	(+)	Yellow/Black	Yellow/Black	N/A	N/A
VSS (vehicle speed sensor)	(DATA)	Pink	Green/White	N/A	Pink



INSTALL GUIDE TOYOTA AVALON WITH JBL 2015-2018

RETAINS FACTORY AMPLIFIER, STEERING WHEEL CONTROLS, AND MORE!



PRODUCTS REQUIRED

iDatalink Maestro RR Radio Replacement Interface
iDatalink Maestro T02 Installation Harness

OPTIONAL ACCESSORIES

PROGRAMMED FIRMWARE

ADS-RR(SR)-TOY02-DS

NOTICE: Automotive Data Solutions Inc. (ADS) recommends having this installation performed by a certified technician. Logos and trademarks used here in are the properties of their respective owners.

WELCOME

Congratulations on the purchase of your iDatalink Maestro RR Radio replacement solution. You are now a few simple steps away from enjoying your new car radio with enhanced features.

Before starting your installation, please ensure that your iDatalink Maestro module is programmed with the correct firmware and that you carefully review the Installation Diagram and Vehicle Wire Reference Chart.

Please note that Maestro RR will only retain functionalities that were originally available in the vehicle.

NEED HELP?

 **1 866 427-2999**

 **support@idatalink.com**

 **maestro.idatalink.com/support
www.12voltdata.com/forum**

DURING INSTALLATION

Installation Instructions	3
Wiring Diagram	4
Radio Wire Reference Chart	5

INSTALLATION INSTRUCTIONS

STEP 1

- Unbox the aftermarket radio and locate its main harness.
- Connect the wires shown on the next page from aftermarket radio main harness to the T02 T-harness and match the wire functions.
- Remove the factory radio.

STEP 2

- If the vehicle is equipped with an OEM backup camera, connect the T02 T-harness to the backup camera harness.

STEP 3

- Connect the factory harness to the T02 T-harness.

STEP 4

- Plug the aftermarket radio harnesses into the aftermarket radio.
- Connect the backup camera RCA cable into the aftermarket radio (if equipped).
- Connect the auxiliary RCA cables into the aftermarket radio (if equipped).
- Plug the Data cable to the data port of the aftermarket radio.

STEP 5

- Connect all the harnesses to the Maestro RR module then test your installation.

TROUBLESHOOTING TIPS:

- To reset the module back its factory settings, turn the key to the OFF position then disconnect all connectors from the module. Press and hold the module's programming button and connect all the connectors back to the module. Wait, the module's LED will flash RED rapidly (this may take up to 10 seconds). Release the programming button. Wait, the LED will turn solid GREEN for 2 seconds.
- For technical assistance call 1-866-427-2999 or e-mail "support@idatalink.com". Visit us at "maestro.idatalink.com/support" and "www.12voltdata.com/forum/"

WIRING DIAGRAM *with an Amplifier*

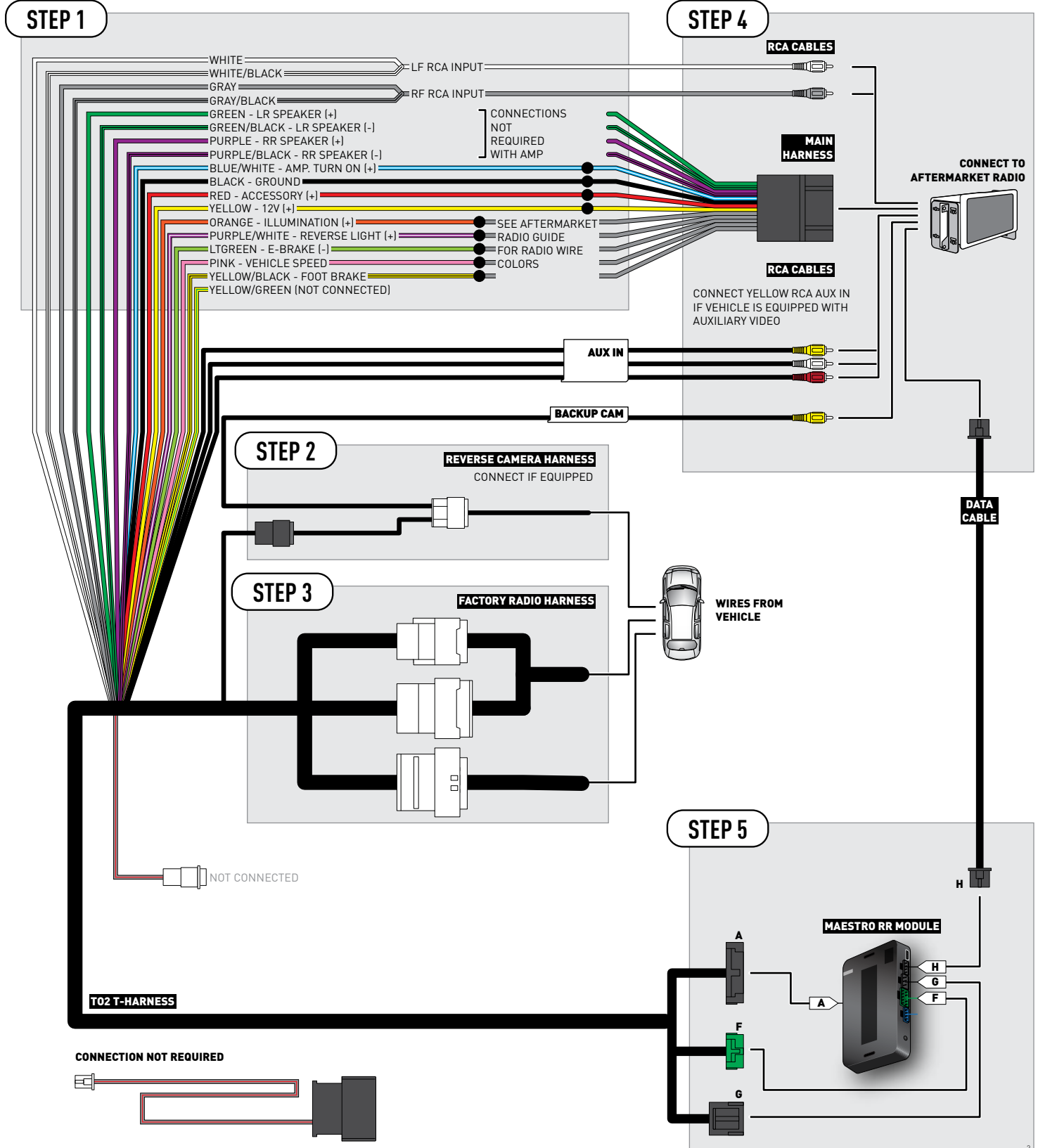

RADIO WIRE REFERENCE CHART

Wire Description	Polarity	Wire Color on Maestro T-Harness	Wire Color on Alpine cable	Wire Color on Kenwood cable	Wire Color on Pioneer cable
Illumination	(+)	Orange	N/A	Orange/White	Orange/White
Reverse Light	(+)	Purple/White or Yellow/Green (see Wiring diagram)	Orange/White	Purple/White	Purple/White
E-Brake	(-)	Lt Green	Yellow/Blue	Lt Green	Lt Green
Foot Brake	(+)	Yellow/Black	Yellow/Black	N/A	N/A
VSS (vehicle speed sensor)	(DATA)	Pink	Green/White	N/A	Pink



INSTALL GUIDE TOYOTA AVALON WITHOUT JBL 2015-2018

RETAINS FACTORY AMPLIFIER, STEERING WHEEL CONTROLS, AND MORE!



PRODUCTS REQUIRED

iDatalink Maestro RR Radio Replacement Interface
iDatalink Maestro T02 Installation Harness

OPTIONAL ACCESSORIES

PROGRAMMED FIRMWARE

ADS-RR(SR)-TOY02-DS

NOTICE: Automotive Data Solutions Inc. (ADS) recommends having this installation performed by a certified technician. Logos and trademarks used here in are the properties of their respective owners.

WELCOME

Congratulations on the purchase of your iDatalink Maestro RR Radio replacement solution. You are now a few simple steps away from enjoying your new car radio with enhanced features.

Before starting your installation, please ensure that your iDatalink Maestro module is programmed with the correct firmware and that you carefully review the Installation Diagram and Vehicle Wire Reference Chart.

Please note that Maestro RR will only retain functionalities that were originally available in the vehicle.

NEED HELP?

 **1 866 427-2999**

 **support@idatalink.com**

 **maestro.idatalink.com/support
www.12voltdata.com/forum**

DURING INSTALLATION

Installation Instructions	3
Wiring Diagram	4
Radio Wire Reference Chart	5

INSTALLATION INSTRUCTIONS

STEP 1

- Unbox the aftermarket radio and locate its main harness.
- Cut and remove the front speaker wire junction connectors.
- Connect the wires shown on the next page from aftermarket radio main harness to the T02 T-harness and match the wire functions.
- Remove the factory radio.

STEP 2

- If the vehicle is equipped with an OEM backup camera, connect the T02 T-harness to the backup camera harness.

STEP 3

- Connect the factory harness to the T02 T-harness.

STEP 4

- Plug the aftermarket radio harnesses into the aftermarket radio.
- Connect the backup camera RCA cable into the aftermarket radio (if equipped).
- Connect the auxiliary RCA cables into the aftermarket radio (if equipped).
- Plug the Data cable to the data port of the aftermarket radio.

STEP 5

- Connect all the harnesses to the Maestro RR module then test your installation.

TROUBLESHOOTING TIPS:

- To reset the module back its factory settings, turn the key to the OFF position then disconnect all connectors from the module. Press and hold the module's programming button and connect all the connectors back to the module. Wait, the module's LED will flash RED rapidly (this may take up to 10 seconds). Release the programming button. Wait, the LED will turn solid GREEN for 2 seconds.
- For technical assistance call 1-866-427-2999 or e-mail "support@idatalink.com". Visit us at "maestro.idatalink.com/support" and "www.12voltdata.com/forum/"

WIRING DIAGRAM *without an Amplifier*

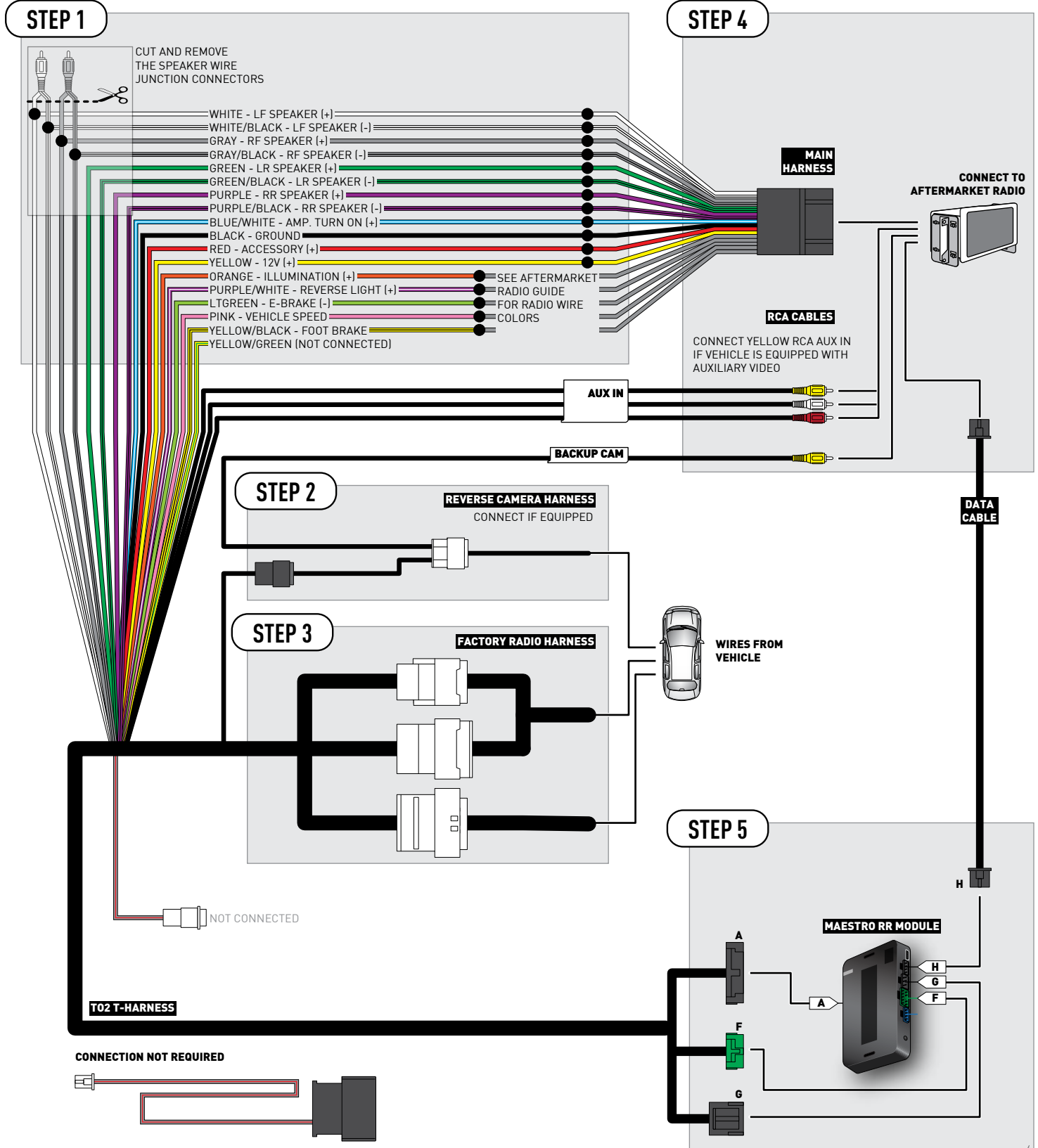

RADIO WIRE REFERENCE CHART

Wire Description	Polarity	Wire Color on Maestro T-Harness	Wire Color on Alpine cable	Wire Color on Kenwood cable	Wire Color on Pioneer cable
Illumination	(+)	Orange	N/A	Orange/White	Orange/White
Reverse Light	(+)	Purple/White or Yellow/Green (see Wiring diagram)	Orange/White	Purple/White	Purple/White
E-Brake	(-)	Lt Green	Yellow/Blue	Lt Green	Lt Green
Foot Brake	(+)	Yellow/Black	Yellow/Black	N/A	N/A
VSS (vehicle speed sensor)	(DATA)	Pink	Green/White	N/A	Pink



INSTALL GUIDE TOYOTA CAMRY WITH FACTORY 6.1" SCREEN 2012-2014

RETAINS FACTORY AMPLIFIER, STEERING WHEEL CONTROLS, AND MORE!



PRODUCTS REQUIRED

iDatalink Maestro RR Radio Replacement Interface
iDatalink Maestro T02 Installation Harness

OPTIONAL ACCESSORIES

PROGRAMMED FIRMWARE

ADS-RR(SR)-TOY02-DS

NOTICE: Automotive Data Solutions Inc. (ADS) recommends having this installation performed by a certified technician. Logos and trademarks used here in are the properties of their respective owners.

WELCOME

Congratulations on the purchase of your iDatalink Maestro RR Radio replacement solution. You are now a few simple steps away from enjoying your new car radio with enhanced features.

Before starting your installation, please ensure that your iDatalink Maestro module is programmed with the correct firmware and that you carefully review the Installation Diagram and Vehicle Wire Reference Chart.

Please note that Maestro RR will only retain functionalities that were originally available in the vehicle.

NEED HELP?

 **1 866 427-2999**

 **support@idatalink.com**

 **maestro.idatalink.com/support**
www.12voltdata.com/forum

DURING INSTALLATION

Installation Instructions	3
Wiring Diagram	4
Radio Wire Reference Chart	5

INSTALLATION INSTRUCTIONS

STEP 1

- Unbox the aftermarket radio and locate its main harness.
- Cut and remove the front speaker wire junction connectors.
- Connect the wires shown on the next page from aftermarket radio main harness to the T02 T-harness and match the wire functions.
- Remove the factory radio.

STEP 2

- If the vehicle is equipped with an OEM backup camera: Cut the reverse camera plug of the T02 T-harness and connect the wires as indicated in the wiring diagram next page (BROWN/RED and BROWN/YELLOW wires are not used).

STEP 3

- Connect the factory harness to the T02 T-harness.

STEP 4

- Plug the aftermarket radio harnesses into the aftermarket radio.
- Connect the backup camera RCA cable into the aftermarket radio (if equipped).
- Connect the auxiliary RCA cables into the aftermarket radio (if equipped).
- Plug the Data cable to the data port of the aftermarket radio.

STEP 5

- Connect all the harnesses to the Maestro RR module then test your installation.

TROUBLESHOOTING TIPS:

- To reset the module back its factory settings, turn the key to the OFF position then disconnect all connectors from the module. Press and hold the module's programming button and connect all the connectors back to the module. Wait, the module's LED will flash RED rapidly (this may take up to 10 seconds). Release the programming button. Wait, the LED will turn solid GREEN for 2 seconds.
- For technical assistance call 1-866-427-2999 or e-mail "support@idatalink.com". Visit us at "maestro.idatalink.com/support" and "www.12voltdata.com/forum/"

WIRING DIAGRAM *without an Amplifier*

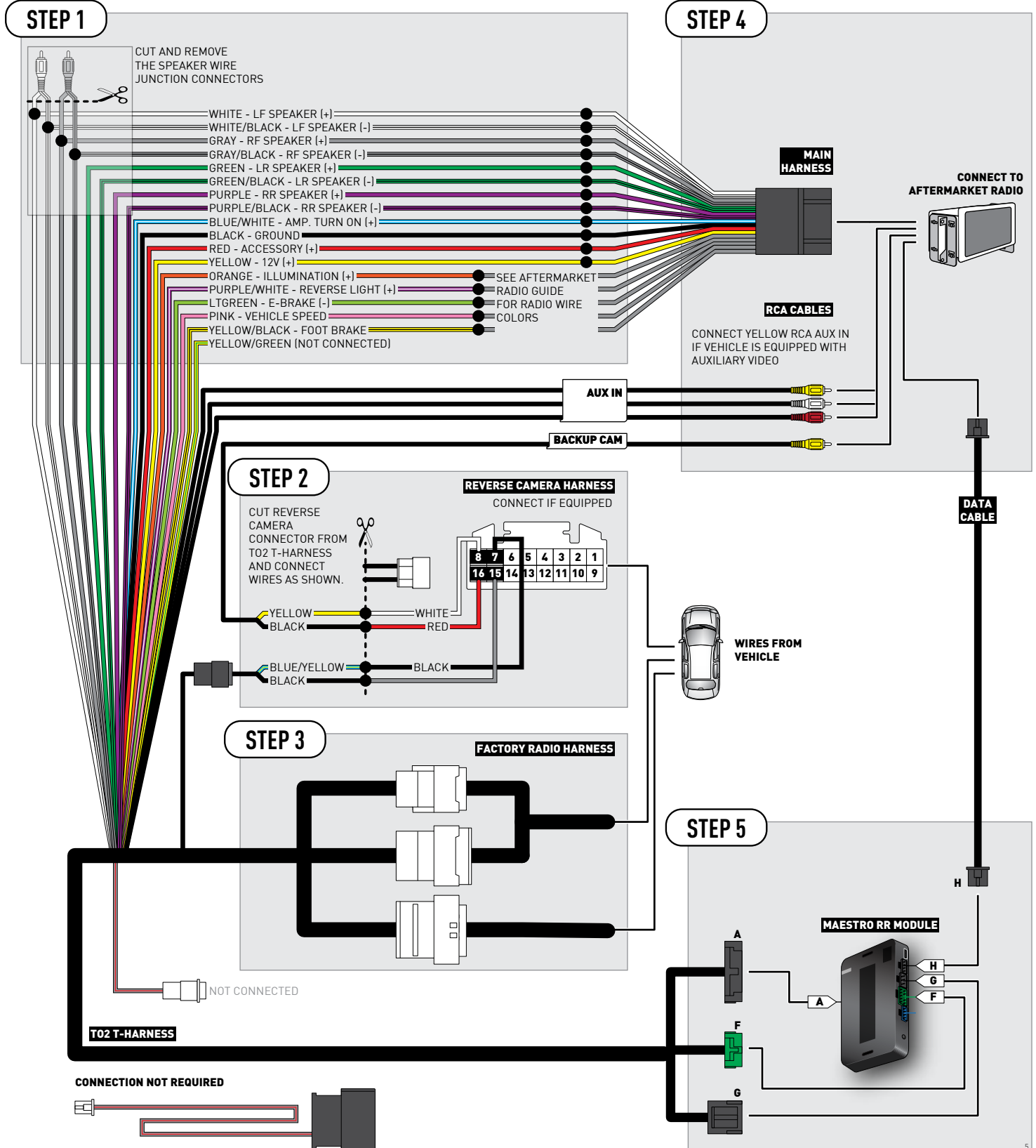

RADIO WIRE REFERENCE CHART

Wire Description	Polarity	Wire Color on Maestro T-Harness	Wire Color on Alpine cable	Wire Color on Kenwood cable	Wire Color on Pioneer cable
Illumination	(+)	Orange	N/A	Orange/White	Orange/White
Reverse Light	(+)	Purple/White or Yellow/Green (see Wiring diagram)	Orange/White	Purple/White	Purple/White
E-Brake	(-)	Lt Green	Yellow/Blue	Lt Green	Lt Green
Foot Brake	(+)	Yellow/Black	Yellow/Black	N/A	N/A
VSS (vehicle speed sensor)	(DATA)	Pink	Green/White	N/A	Pink



INSTALL GUIDE TOYOTA CAMRY WITH FACTORY 6.1" SCREEN AND JBL 2012-2014

RETAINS FACTORY AMPLIFIER, STEERING WHEEL CONTROLS, AND MORE!



PRODUCTS REQUIRED

iDatalink Maestro RR Radio Replacement Interface
iDatalink Maestro T02 Installation Harness

OPTIONAL ACCESSORIES

PROGRAMMED FIRMWARE

ADS-RR(SR)-TOY02-DS

NOTICE: Automotive Data Solutions Inc. (ADS) recommends having this installation performed by a certified technician. Logos and trademarks used here in are the properties of their respective owners.

WELCOME

Congratulations on the purchase of your iDatalink Maestro RR Radio replacement solution. You are now a few simple steps away from enjoying your new car radio with enhanced features.

Before starting your installation, please ensure that your iDatalink Maestro module is programmed with the correct firmware and that you carefully review the Installation Diagram and Vehicle Wire Reference Chart.

Please note that Maestro RR will only retain functionalities that were originally available in the vehicle.

NEED HELP?

 **1 866 427-2999**

 **support@idatalink.com**

 **maestro.idatalink.com/support
www.12voltdata.com/forum**

DURING INSTALLATION

Installation Instructions	3
Wiring Diagram	4
Radio Wire Reference Chart	5

INSTALLATION INSTRUCTIONS

STEP 1

- Unbox the aftermarket radio and locate its main harness.
- Connect the wires shown on the next page from aftermarket radio main harness to the T02 T-harness and match the wire functions.
- Remove the factory radio.

STEP 2

- If the vehicle is equipped with an OEM backup camera: Cut the reverse camera plug of the T02 T-harness and connect the wires as indicated in the wiring diagram next page (BROWN/RED and BROWN/YELLOW wires are not used).

STEP 3

- Connect the factory harness to the T02 T-harness.

STEP 4

- Plug the aftermarket radio harnesses into the aftermarket radio.
- Connect the backup camera RCA cable into the aftermarket radio (if equipped).
- Connect the auxiliary RCA cables into the aftermarket radio (if equipped).
- Plug the Data cable to the data port of the aftermarket radio.

STEP 5

- Connect all the harnesses to the Maestro RR module then test your installation.

TROUBLESHOOTING TIPS:

- To reset the module back its factory settings, turn the key to the OFF position then disconnect all connectors from the module. Press and hold the module's programming button and connect all the connectors back to the module. Wait, the module's LED will flash RED rapidly (this may take up to 10 seconds). Release the programming button. Wait, the LED will turn solid GREEN for 2 seconds.
- For technical assistance call 1-866-427-2999 or e-mail "support@idatalink.com". Visit us at "maestro.idatalink.com/support" and "www.12voldata.com/forum/"

WIRING DIAGRAM *with an Amplifier*

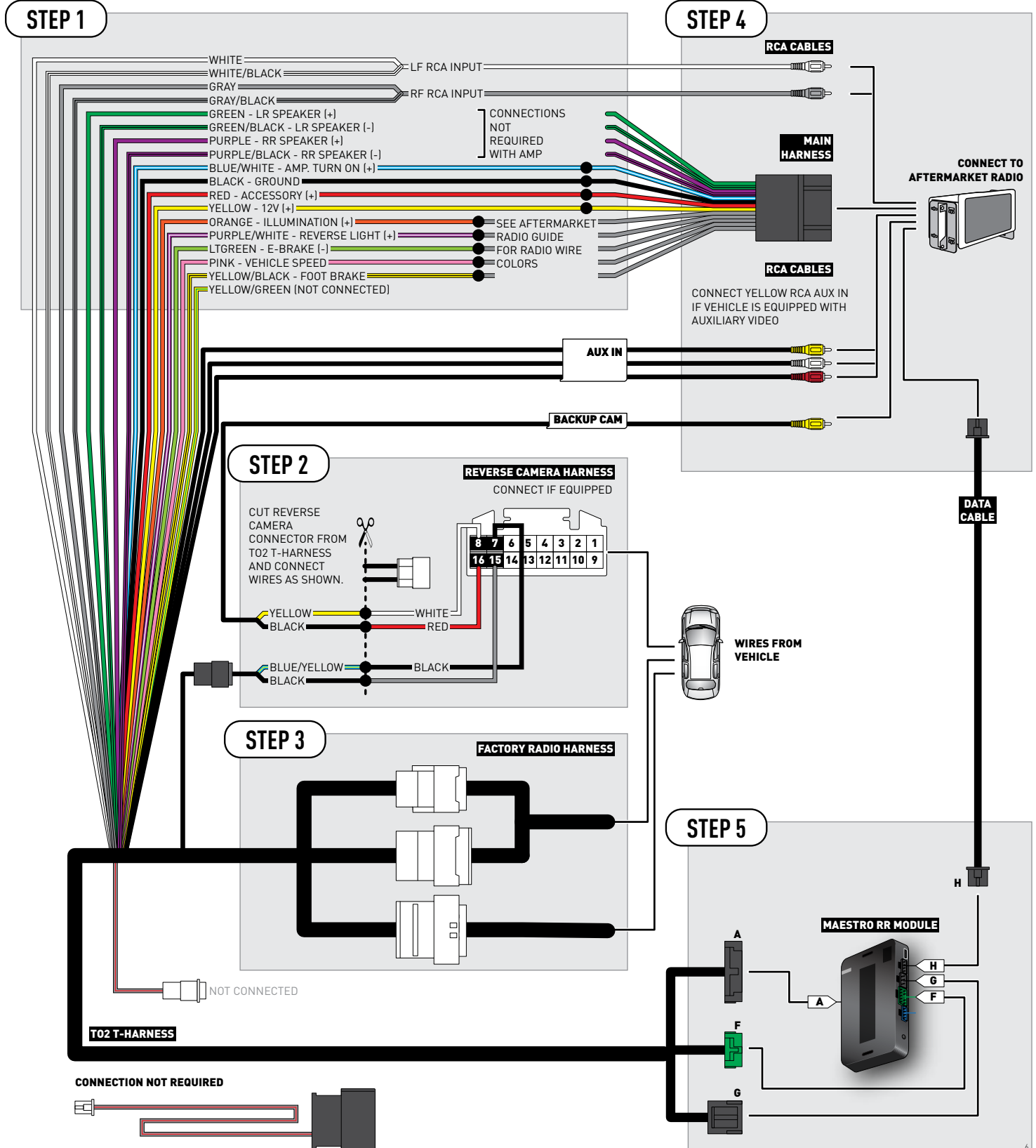

RADIO WIRE REFERENCE CHART

Wire Description	Polarity	Wire Color on Maestro T-Harness	Wire Color on Alpine cable	Wire Color on Kenwood cable	Wire Color on Pioneer cable
Illumination	(+)	Orange	N/A	Orange/White	Orange/White
Reverse Light	(+)	Purple/White or Yellow/Green (see Wiring diagram)	Orange/White	Purple/White	Purple/White
E-Brake	(-)	Lt Green	Yellow/Blue	Lt Green	Lt Green
Foot Brake	(+)	Yellow/Black	Yellow/Black	N/A	N/A
VSS (vehicle speed sensor)	(DATA)	Pink	Green/White	N/A	Pink



INSTALL GUIDE TOYOTA CAMRY WITH FACTORY SCREEN AND HDD AND JBL 2012-2014

RETAINS FACTORY AMPLIFIER, STEERING WHEEL CONTROLS, AND MORE!



PRODUCTS REQUIRED

iDatalink Maestro RR Radio Replacement Interface
iDatalink Maestro T02 Installation Harness

OPTIONAL ACCESSORIES

PROGRAMMED FIRMWARE

ADS-RR(SR)-TOY02-DS

NOTICE: Automotive Data Solutions Inc. (ADS) recommends having this installation performed by a certified technician. Logos and trademarks used here in are the properties of their respective owners.

WELCOME

Congratulations on the purchase of your iDatalink Maestro RR Radio replacement solution. You are now a few simple steps away from enjoying your new car radio with enhanced features.

Before starting your installation, please ensure that your iDatalink Maestro module is programmed with the correct firmware and that you carefully review the Installation Diagram and Vehicle Wire Reference Chart.

Please note that Maestro RR will only retain functionalities that were originally available in the vehicle.

NEED HELP?

 **1 866 427-2999**

 support@idatalink.com

 maestro.idatalink.com/support
www.12voltdata.com/forum

DURING INSTALLATION

Installation Instructions	3
Wiring Diagram	4
Radio Wire Reference Chart	5

INSTALLATION INSTRUCTIONS

STEP 1

- Unbox the aftermarket radio and locate its main harness.
- Connect the wires shown on the next page from aftermarket radio main harness to the T02 T-harness and match the wire functions.
- Remove the factory radio.

STEP 2

- If the vehicle is equipped with an OEM backup camera: Cut the reverse camera plug of the T02 T-harness and connect the wires as indicated in the wiring diagram next page (BROWN/RED and BROWN/YELLOW wires are not used).

STEP 3

- Connect the factory harness to the T02 T-harness.

STEP 4

- Plug the aftermarket radio harnesses into the aftermarket radio.
- Connect the backup camera RCA cable into the aftermarket radio (if equipped).
- Connect the auxiliary RCA cables into the aftermarket radio (if equipped).
- Plug the Data cable to the data port of the aftermarket radio.

STEP 5

- Connect all the harnesses to the Maestro RR module then test your installation.

TROUBLESHOOTING TIPS:

- To reset the module back its factory settings, turn the key to the OFF position then disconnect all connectors from the module. Press and hold the module's programming button and connect all the connectors back to the module. Wait, the module's LED will flash RED rapidly (this may take up to 10 seconds). Release the programming button. Wait, the LED will turn solid GREEN for 2 seconds.
- For technical assistance call 1-866-427-2999 or e-mail "support@idatalink.com". Visit us at "maestro.idatalink.com/support" and "www.12voldata.com/forum/"

WIRING DIAGRAM *with an Amplifier*

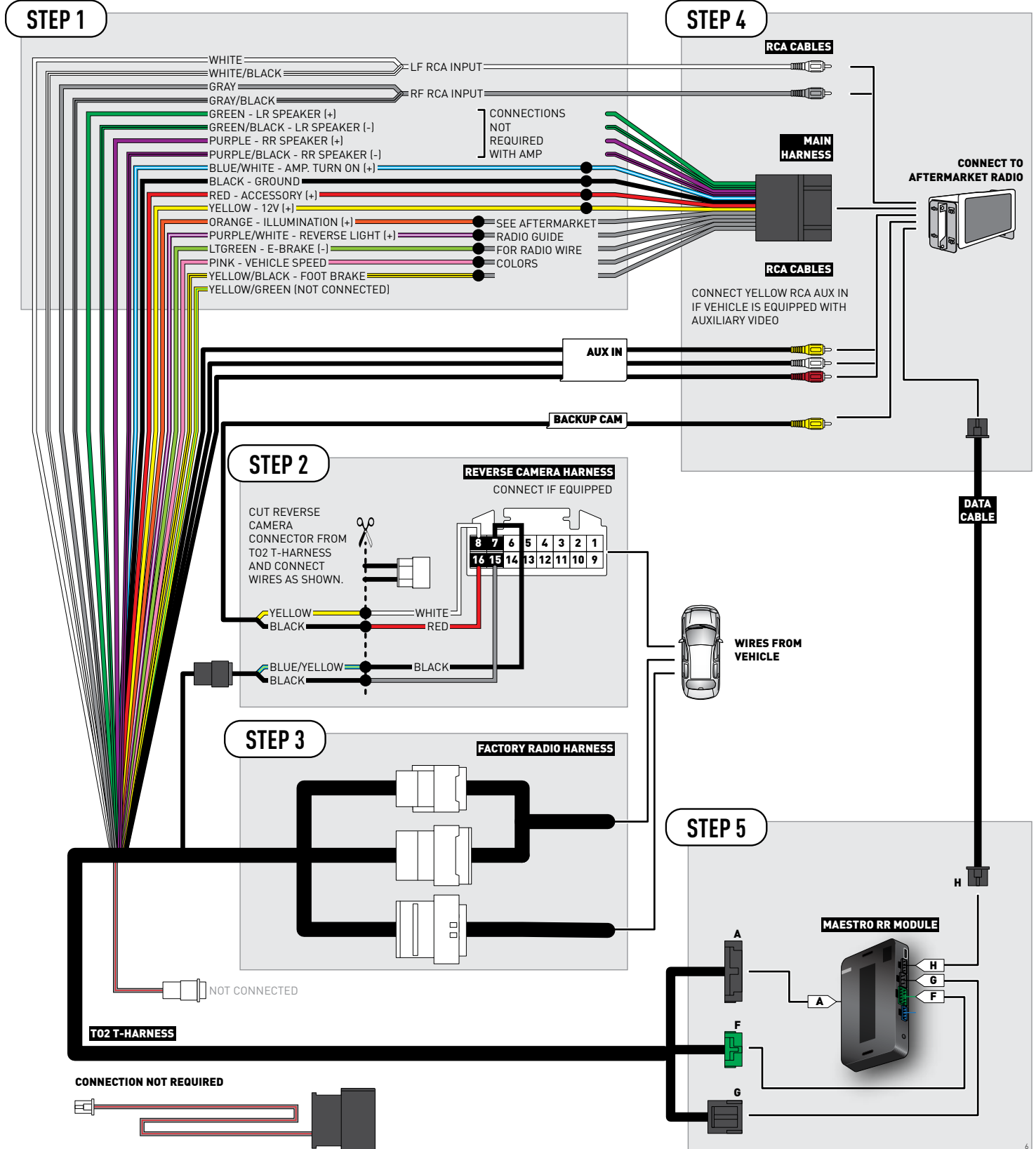

RADIO WIRE REFERENCE CHART

Wire Description	Polarity	Wire Color on Maestro T-Harness	Wire Color on Alpine cable	Wire Color on Kenwood cable	Wire Color on Pioneer cable
Illumination	(+)	Orange	N/A	Orange/White	Orange/White
Reverse Light	(+)	Purple/White or Yellow/Green (see Wiring diagram)	Orange/White	Purple/White	Purple/White
E-Brake	(-)	Lt Green	Yellow/Blue	Lt Green	Lt Green
Foot Brake	(+)	Yellow/Black	Yellow/Black	N/A	N/A
VSS (vehicle speed sensor)	(DATA)	Pink	Green/White	N/A	Pink



INSTALL GUIDE TOYOTA CAMRY WITH JBL 2015-2017

RETAINS FACTORY AMPLIFIER, STEERING WHEEL CONTROLS, AND MORE!



PRODUCTS REQUIRED

iDatalink Maestro RR Radio Replacement Interface
iDatalink Maestro T02 Installation Harness

OPTIONAL ACCESSORIES

PROGRAMMED FIRMWARE

ADS-RR(SR)-TOY02-DS

NOTICE: Automotive Data Solutions Inc. (ADS) recommends having this installation performed by a certified technician. Logos and trademarks used here in are the properties of their respective owners.

WELCOME

Congratulations on the purchase of your iDatalink Maestro RR Radio replacement solution. You are now a few simple steps away from enjoying your new car radio with enhanced features.

Before starting your installation, please ensure that your iDatalink Maestro module is programmed with the correct firmware and that you carefully review the Installation Diagram and Vehicle Wire Reference Chart.

Please note that Maestro RR will only retain functionalities that were originally available in the vehicle.

NEED HELP?

 **1 866 427-2999**

 **support@idatalink.com**

 **maestro.idatalink.com/support**
www.12voltdata.com/forum

DURING INSTALLATION

Installation Instructions	3
Wiring Diagram	4
Radio Wire Reference Chart	5

INSTALLATION INSTRUCTIONS

STEP 1

- Unbox the aftermarket radio and locate its main harness.
- Connect the wires shown on the next page from aftermarket radio main harness to the T02 T-harness and match the wire functions.
- Remove the factory radio.

STEP 2

- If the vehicle is equipped with an OEM backup camera, connect the T02 T-harness to the backup camera harness.

STEP 3

- Connect the factory harness to the T02 T-harness.

STEP 4

- Plug the aftermarket radio harnesses into the aftermarket radio.
- Connect the backup camera RCA cable into the aftermarket radio (if equipped).
- Connect the auxiliary RCA cables into the aftermarket radio (if equipped).
- Plug the Data cable to the data port of the aftermarket radio.

STEP 5

- Connect all the harnesses to the Maestro RR module then test your installation.

TROUBLESHOOTING TIPS:

- To reset the module back its factory settings, turn the key to the OFF position then disconnect all connectors from the module. Press and hold the module's programming button and connect all the connectors back to the module. Wait, the module's LED will flash RED rapidly (this may take up to 10 seconds). Release the programming button. Wait, the LED will turn solid GREEN for 2 seconds.
- For technical assistance call 1-866-427-2999 or e-mail "support@idatalink.com". Visit us at "maestro.idatalink.com/support" and "www.12voltdata.com/forum/"

WIRING DIAGRAM *with an Amplifier*

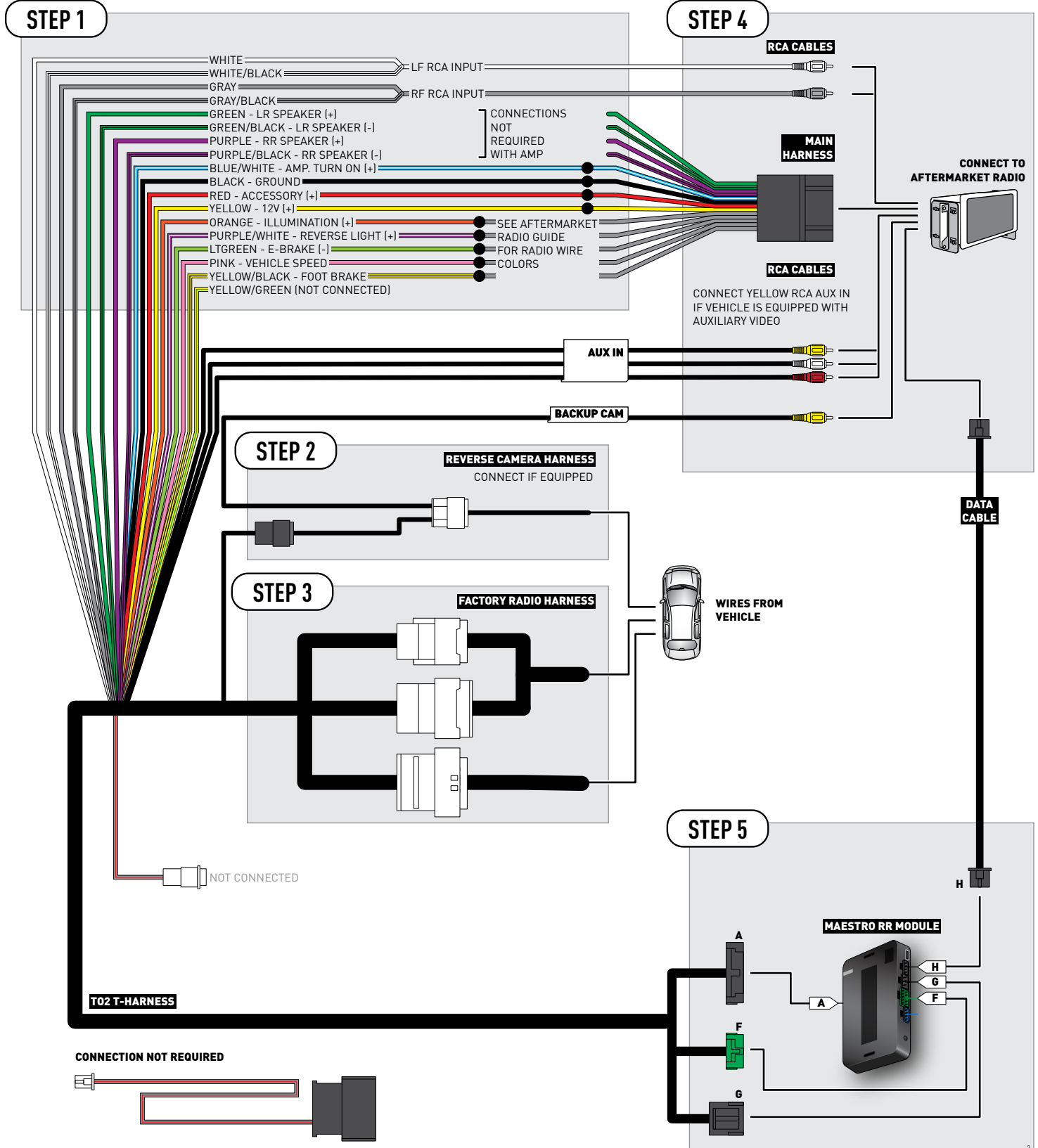

RADIO WIRE REFERENCE CHART

Wire Description	Polarity	Wire Color on Maestro T-Harness	Wire Color on Alpine cable	Wire Color on Kenwood cable	Wire Color on Pioneer cable
Illumination	(+)	Orange	N/A	Orange/White	Orange/White
Reverse Light	(+)	Purple/White or Yellow/Green (see Wiring diagram)	Orange/White	Purple/White	Purple/White
E-Brake	(-)	Lt Green	Yellow/Blue	Lt Green	Lt Green
Foot Brake	(+)	Yellow/Black	Yellow/Black	N/A	N/A
VSS (vehicle speed sensor)	(DATA)	Pink	Green/White	N/A	Pink



INSTALL GUIDE TOYOTA CAMRY WITHOUT JBL 2015-2017

RETAINS FACTORY AMPLIFIER, STEERING WHEEL CONTROLS, AND MORE!



PRODUCTS REQUIRED

iDatalink Maestro RR Radio Replacement Interface
iDatalink Maestro T02 Installation Harness

OPTIONAL ACCESSORIES

PROGRAMMED FIRMWARE

ADS-RR(SR)-TOY02-DS

NOTICE: Automotive Data Solutions Inc. (ADS) recommends having this installation performed by a certified technician. Logos and trademarks used here in are the properties of their respective owners.

WELCOME

Congratulations on the purchase of your iDatalink Maestro RR Radio replacement solution. You are now a few simple steps away from enjoying your new car radio with enhanced features.

Before starting your installation, please ensure that your iDatalink Maestro module is programmed with the correct firmware and that you carefully review the Installation Diagram and Vehicle Wire Reference Chart.

Please note that Maestro RR will only retain functionalities that were originally available in the vehicle.

NEED HELP?

 **1 866 427-2999**

 **support@idatalink.com**

 **maestro.idatalink.com/support**
www.12voltdata.com/forum

DURING INSTALLATION

Installation Instructions	3
Wiring Diagram	4
Radio Wire Reference Chart	5

INSTALLATION INSTRUCTIONS

STEP 1

- Unbox the aftermarket radio and locate its main harness.
- Cut and remove the front speaker wire junction connectors.
- Connect the wires shown on the next page from aftermarket radio main harness to the T02 T-harness and match the wire functions.
- Remove the factory radio.

STEP 2

- If the vehicle is equipped with an OEM backup camera, connect the T02 T-harness to the backup camera harness.

STEP 3

- Connect the factory harness to the T02 T-harness.

STEP 4

- Plug the aftermarket radio harnesses into the aftermarket radio.
- Connect the backup camera RCA cable into the aftermarket radio (if equipped).
- Connect the auxiliary RCA cables into the aftermarket radio (if equipped).
- Plug the Data cable to the data port of the aftermarket radio.

STEP 5

- Connect all the harnesses to the Maestro RR module then test your installation.

TROUBLESHOOTING TIPS:

- To reset the module back its factory settings, turn the key to the OFF position then disconnect all connectors from the module. Press and hold the module's programming button and connect all the connectors back to the module. Wait, the module's LED will flash RED rapidly (this may take up to 10 seconds). Release the programming button. Wait, the LED will turn solid GREEN for 2 seconds.
- For technical assistance call 1-866-427-2999 or e-mail "support@idatalink.com". Visit us at "maestro.idatalink.com/support" and "www.12voltdata.com/forum/"

WIRING DIAGRAM *without an Amplifier*

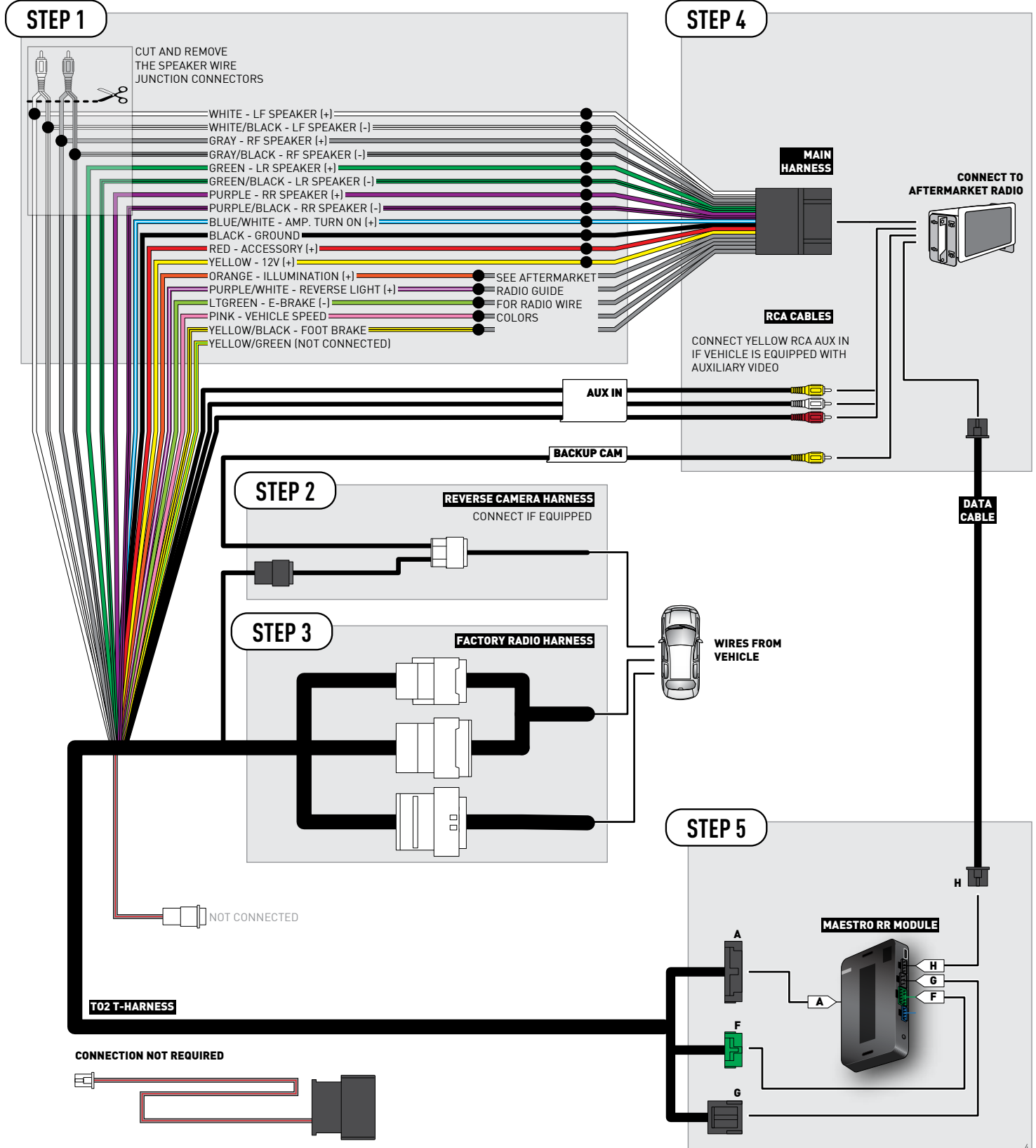

RADIO WIRE REFERENCE CHART

Wire Description	Polarity	Wire Color on Maestro T-Harness	Wire Color on Alpine cable	Wire Color on Kenwood cable	Wire Color on Pioneer cable
Illumination	(+)	Orange	N/A	Orange/White	Orange/White
Reverse Light	(+)	Purple/White or Yellow/Green (see Wiring diagram)	Orange/White	Purple/White	Purple/White
E-Brake	(-)	Lt Green	Yellow/Blue	Lt Green	Lt Green
Foot Brake	(+)	Yellow/Black	Yellow/Black	N/A	N/A
VSS (vehicle speed sensor)	(DATA)	Pink	Green/White	N/A	Pink



INSTALL GUIDE TOYOTA COROLLA WITH FACTORY 6.1" SCREEN 2014-2018

RETAINS FACTORY AMPLIFIER, STEERING WHEEL CONTROLS, AND MORE!



PRODUCTS REQUIRED

iDatalink Maestro RR Radio Replacement Interface
iDatalink Maestro T02 Installation Harness

OPTIONAL ACCESSORIES

PROGRAMMED FIRMWARE

ADS-RR(SR)-TOY02-DS

NOTICE: Automotive Data Solutions Inc. (ADS) recommends having this installation performed by a certified technician. Logos and trademarks used here in are the properties of their respective owners.

WELCOME

Congratulations on the purchase of your iDatalink Maestro RR Radio replacement solution. You are now a few simple steps away from enjoying your new car radio with enhanced features.

Before starting your installation, please ensure that your iDatalink Maestro module is programmed with the correct firmware and that you carefully review the Installation Diagram and Vehicle Wire Reference Chart.

Please note that Maestro RR will only retain functionalities that were originally available in the vehicle.

NEED HELP?

 **1 866 427-2999**

 **support@idatalink.com**

 **maestro.idatalink.com/support
www.12voltdata.com/forum**

DURING INSTALLATION

Installation Instructions	3
Wiring Diagram	4
Radio Wire Reference Chart	5

INSTALLATION INSTRUCTIONS

STEP 1

- Unbox the aftermarket radio and locate its main harness.
- Cut and remove the front speaker wire junction connectors.
- Connect the wires shown on the next page from aftermarket radio main harness to the T02 T-harness and match the wire functions.
- Remove the factory radio.

STEP 2

- If the vehicle is equipped with an OEM backup camera, connect the T02 T-harness to the backup camera harness.

STEP 3

- Connect the factory harness to the T02 T-harness.

STEP 4

- Plug the aftermarket radio harnesses into the aftermarket radio.
- Connect the backup camera RCA cable into the aftermarket radio (if equipped).
- Connect the auxiliary RCA cables into the aftermarket radio (if equipped).
- Plug the Data cable to the data port of the aftermarket radio.

STEP 5

- Connect all the harnesses to the Maestro RR module then test your installation.

TROUBLESHOOTING TIPS:

- To reset the module back its factory settings, turn the key to the OFF position then disconnect all connectors from the module. Press and hold the module's programming button and connect all the connectors back to the module. Wait, the module's LED will flash RED rapidly (this may take up to 10 seconds). Release the programming button. Wait, the LED will turn solid GREEN for 2 seconds.
- For technical assistance call 1-866-427-2999 or e-mail "support@idatalink.com". Visit us at "maestro.idatalink.com/support" and "www.12voltdata.com/forum/"

WIRING DIAGRAM *without an Amplifier*

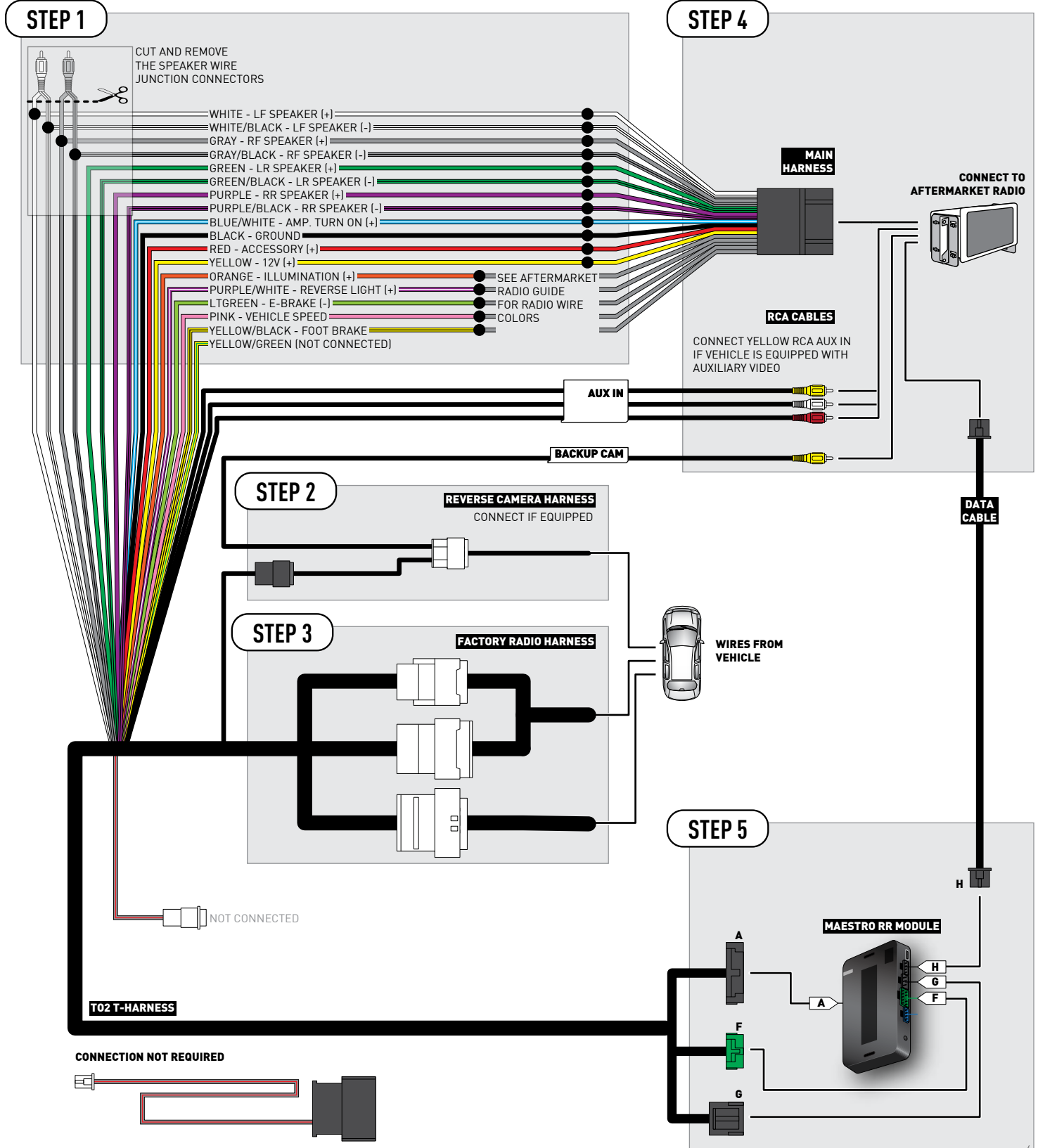

RADIO WIRE REFERENCE CHART

Wire Description	Polarity	Wire Color on Maestro T-Harness	Wire Color on Alpine cable	Wire Color on Kenwood cable	Wire Color on Pioneer cable
Illumination	(+)	Orange	N/A	Orange/White	Orange/White
Reverse Light	(+)	Purple/White or Yellow/Green (see Wiring diagram)	Orange/White	Purple/White	Purple/White
E-Brake	(-)	Lt Green	Yellow/Blue	Lt Green	Lt Green
Foot Brake	(+)	Yellow/Black	Yellow/Black	N/A	N/A
VSS (vehicle speed sensor)	(DATA)	Pink	Green/White	N/A	Pink



INSTALL GUIDE TOYOTA HIGHLANDER WITH JBL 2014-2018

RETAINS FACTORY AMPLIFIER, STEERING WHEEL CONTROLS, AND MORE!



PRODUCTS REQUIRED

iDatalink Maestro RR Radio Replacement Interface
iDatalink Maestro T02 Installation Harness

OPTIONAL ACCESSORIES

PROGRAMMED FIRMWARE

ADS-RR(SR)-TOY02-DS

NOTICE: Automotive Data Solutions Inc. (ADS) recommends having this installation performed by a certified technician. Logos and trademarks used here in are the properties of their respective owners.

WELCOME

Congratulations on the purchase of your iDatalink Maestro RR Radio replacement solution. You are now a few simple steps away from enjoying your new car radio with enhanced features.

Before starting your installation, please ensure that your iDatalink Maestro module is programmed with the correct firmware and that you carefully review the Installation Diagram and Vehicle Wire Reference Chart.

Please note that Maestro RR will only retain functionalities that were originally available in the vehicle.

NEED HELP?

 **1 866 427-2999**

 **support@idatalink.com**

 **maestro.idatalink.com/support**
www.12voltdata.com/forum

DURING INSTALLATION

Installation Instructions	3
Wiring Diagram	4
Radio Wire Reference Chart	5

INSTALLATION INSTRUCTIONS

STEP 1

- Unbox the aftermarket radio and locate its main harness.
- Connect the wires shown on the next page from aftermarket radio main harness to the T02 T-harness and match the wire functions.
- Remove the factory radio.

STEP 2

- If the vehicle is equipped with an OEM backup camera, connect the T02 T-harness to the backup camera harness.

STEP 3

- Connect the factory harness to the T02 T-harness.

STEP 4

- Plug the aftermarket radio harnesses into the aftermarket radio.
- Connect the backup camera RCA cable into the aftermarket radio (if equipped).
- Connect the auxiliary RCA cables into the aftermarket radio (if equipped).
- Plug the Data cable to the data port of the aftermarket radio.

STEP 5

- Connect all the harnesses to the Maestro RR module then test your installation.

TROUBLESHOOTING TIPS:

- To reset the module back its factory settings, turn the key to the OFF position then disconnect all connectors from the module. Press and hold the module's programming button and connect all the connectors back to the module. Wait, the module's LED will flash RED rapidly (this may take up to 10 seconds). Release the programming button. Wait, the LED will turn solid GREEN for 2 seconds.
- For technical assistance call 1-866-427-2999 or e-mail "support@idatalink.com". Visit us at "maestro.idatalink.com/support" and "www.12voltdata.com/forum/"

WIRING DIAGRAM *with an Amplifier*

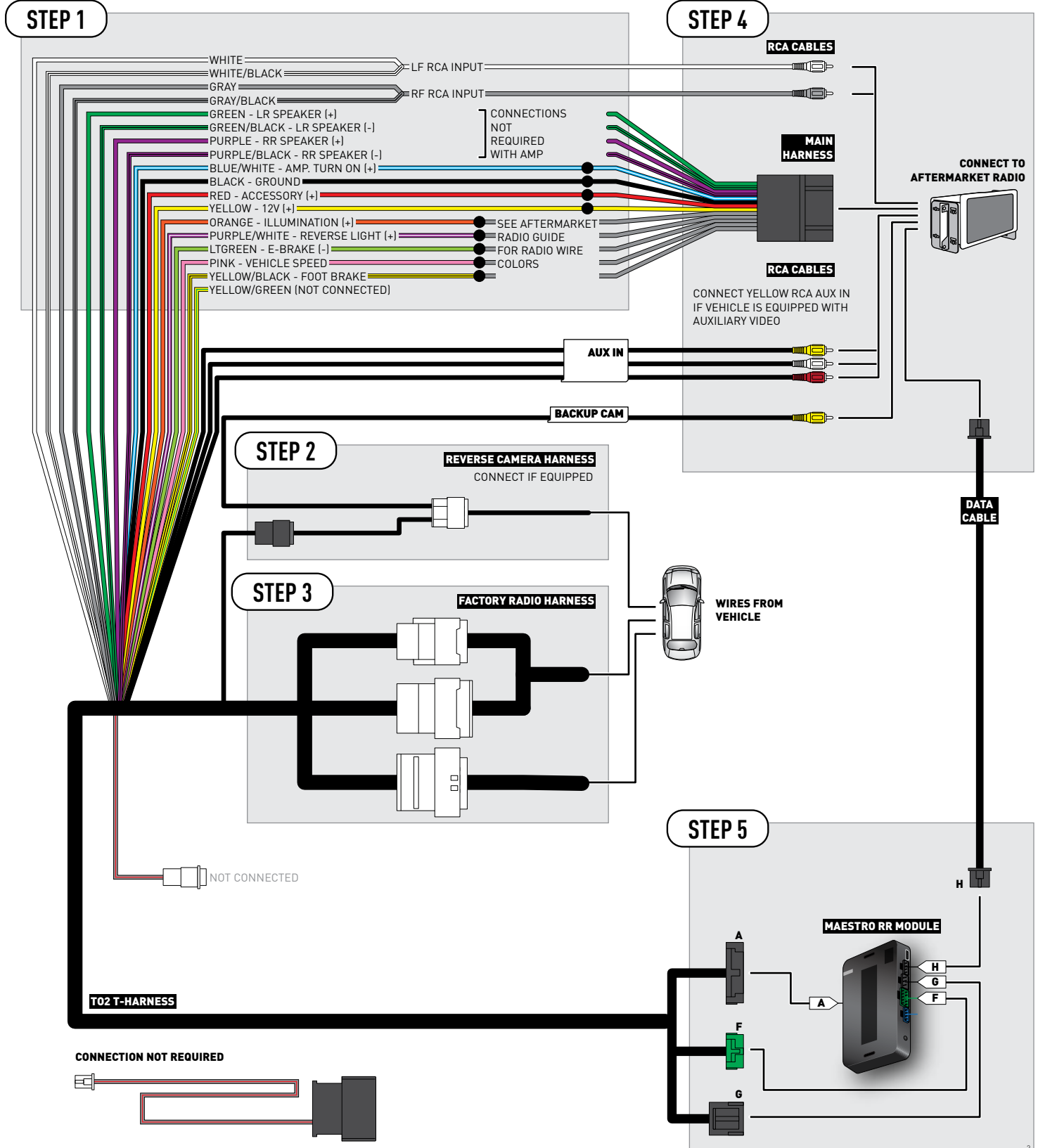

RADIO WIRE REFERENCE CHART

Wire Description	Polarity	Wire Color on Maestro T-Harness	Wire Color on Alpine cable	Wire Color on Kenwood cable	Wire Color on Pioneer cable
Illumination	(+)	Orange	N/A	Orange/White	Orange/White
Reverse Light	(+)	Purple/White or Yellow/Green (see Wiring diagram)	Orange/White	Purple/White	Purple/White
E-Brake	(-)	Lt Green	Yellow/Blue	Lt Green	Lt Green
Foot Brake	(+)	Yellow/Black	Yellow/Black	N/A	N/A
VSS (vehicle speed sensor)	(DATA)	Pink	Green/White	N/A	Pink



INSTALL GUIDE TOYOTA HIGHLANDER WITHOUT JBL 2014-2018

RETAINS FACTORY AMPLIFIER, STEERING WHEEL CONTROLS, AND MORE!



PRODUCTS REQUIRED

iDatalink Maestro RR Radio Replacement Interface
iDatalink Maestro T02 Installation Harness

OPTIONAL ACCESSORIES

PROGRAMMED FIRMWARE

ADS-RR(SR)-TOY02-DS

NOTICE: Automotive Data Solutions Inc. (ADS) recommends having this installation performed by a certified technician. Logos and trademarks used here in are the properties of their respective owners.

WELCOME

Congratulations on the purchase of your iDatalink Maestro RR Radio replacement solution. You are now a few simple steps away from enjoying your new car radio with enhanced features.

Before starting your installation, please ensure that your iDatalink Maestro module is programmed with the correct firmware and that you carefully review the Installation Diagram and Vehicle Wire Reference Chart.

Please note that Maestro RR will only retain functionalities that were originally available in the vehicle.

NEED HELP?

 **1 866 427-2999**

 support@idatalink.com

 maestro.idatalink.com/support
www.12voltdata.com/forum

DURING INSTALLATION

Installation Instructions	3
Wiring Diagram	4
Radio Wire Reference Chart	5

INSTALLATION INSTRUCTIONS

STEP 1

- Unbox the aftermarket radio and locate its main harness.
- Cut and remove the front speaker wire junction connectors.
- Connect the wires shown on the next page from aftermarket radio main harness to the T02 T-harness and match the wire functions.
- Remove the factory radio.

STEP 2

- If the vehicle is equipped with an OEM backup camera, connect the T02 T-harness to the backup camera harness.

STEP 3

- Connect the factory harness to the T02 T-harness.

STEP 4

- Plug the aftermarket radio harnesses into the aftermarket radio.
- Connect the backup camera RCA cable into the aftermarket radio (if equipped).
- Connect the auxiliary RCA cables into the aftermarket radio (if equipped).
- Plug the Data cable to the data port of the aftermarket radio.

STEP 5

- Connect all the harnesses to the Maestro RR module then test your installation.

TROUBLESHOOTING TIPS:

- To reset the module back its factory settings, turn the key to the OFF position then disconnect all connectors from the module. Press and hold the module's programming button and connect all the connectors back to the module. Wait, the module's LED will flash RED rapidly (this may take up to 10 seconds). Release the programming button. Wait, the LED will turn solid GREEN for 2 seconds.
- For technical assistance call 1-866-427-2999 or e-mail "support@idatalink.com". Visit us at "maestro.idatalink.com/support" and "www.12voltdata.com/forum/"

WIRING DIAGRAM *without an Amplifier*

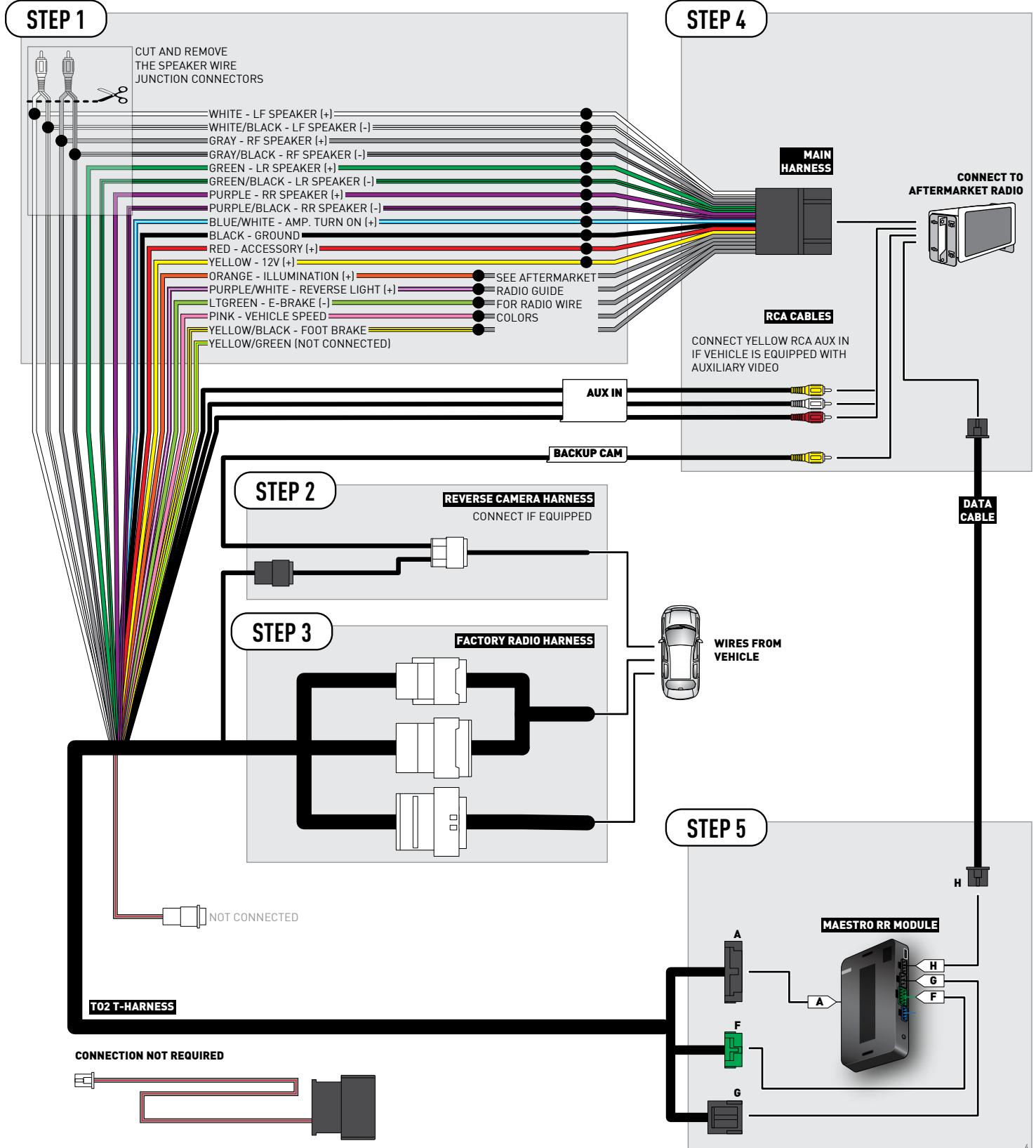

RADIO WIRE REFERENCE CHART

Wire Description	Polarity	Wire Color on Maestro T-Harness	Wire Color on Alpine cable	Wire Color on Kenwood cable	Wire Color on Pioneer cable
Illumination	(+)	Orange	N/A	Orange/White	Orange/White
Reverse Light	(+)	Purple/White or Yellow/Green (see Wiring diagram)	Orange/White	Purple/White	Purple/White
E-Brake	(-)	Lt Green	Yellow/Blue	Lt Green	Lt Green
Foot Brake	(+)	Yellow/Black	Yellow/Black	N/A	N/A
VSS (vehicle speed sensor)	(DATA)	Pink	Green/White	N/A	Pink



INSTALL GUIDE TOYOTA PRIUS BASE 2016-2018

RETAINS FACTORY AMPLIFIER, STEERING WHEEL CONTROLS, AND MORE!



PRODUCTS REQUIRED

iDatalink Maestro RR Radio Replacement Interface
iDatalink Maestro T02 Installation Harness

OPTIONAL ACCESSORIES

PROGRAMMED FIRMWARE

ADS-RR(SR)-TOY02-DS

NOTICE: Automotive Data Solutions Inc. (ADS) recommends having this installation performed by a certified technician. Logos and trademarks used here in are the properties of their respective owners.

WELCOME

Congratulations on the purchase of your iDatalink Maestro RR Radio replacement solution. You are now a few simple steps away from enjoying your new car radio with enhanced features.

Before starting your installation, please ensure that your iDatalink Maestro module is programmed with the correct firmware and that you carefully review the Installation Diagram and Vehicle Wire Reference Chart.

Please note that Maestro RR will only retain functionalities that were originally available in the vehicle.

NEED HELP?

 **1 866 427-2999**

 **support@idatalink.com**

 **maestro.idatalink.com/support
www.12voltdata.com/forum**

DURING INSTALLATION

Installation Instructions	3
Wiring Diagram	4
Radio Wire Reference Chart	5

INSTALLATION INSTRUCTIONS

STEP 1

- Unbox the aftermarket radio and locate its main harness.
- Cut and remove the front speaker wire junction connectors.
- Connect the wires shown on the next page from aftermarket radio main harness to the T02 T-harness and match the wire functions.
- Remove the factory radio.

STEP 2

- If the vehicle is equipped with an OEM backup camera, connect the T02 T-harness to the backup camera harness.

STEP 3

- Connect the factory harness to the T02 T-harness.

STEP 4

- Plug the male WHITE 2 pin connector of your T02 T-harness into the OBDII harness.
- Plug the OBDII connector into the OBDII of the vehicle.

STEP 5

- Plug the aftermarket radio harnesses into the aftermarket radio.
- Connect the backup camera RCA cable into the aftermarket radio (if equipped).
- Connect the auxiliary RCA cables into the aftermarket radio (if equipped).
- Plug the Data cable to the data port of the aftermarket radio.

STEP 6

- Connect all the harnesses to the Maestro RR module then test your installation.

TROUBLESHOOTING TIPS:

- To reset the module back its factory settings, turn the key to the OFF position then disconnect all connectors from the module. Press and hold the module's programming button and connect all the connectors back to the module. Wait, the module's LED will flash RED rapidly (this may take up to 10 seconds). Release the programming button. Wait, the LED will turn solid GREEN for 2 seconds.
- For technical assistance call 1-866-427-2999 or e-mail "support@idatalink.com". Visit us at "maestro.idatalink.com/support" and "www.12voltdata.com/forum/"

WIRING DIAGRAM *without an Amplifier*

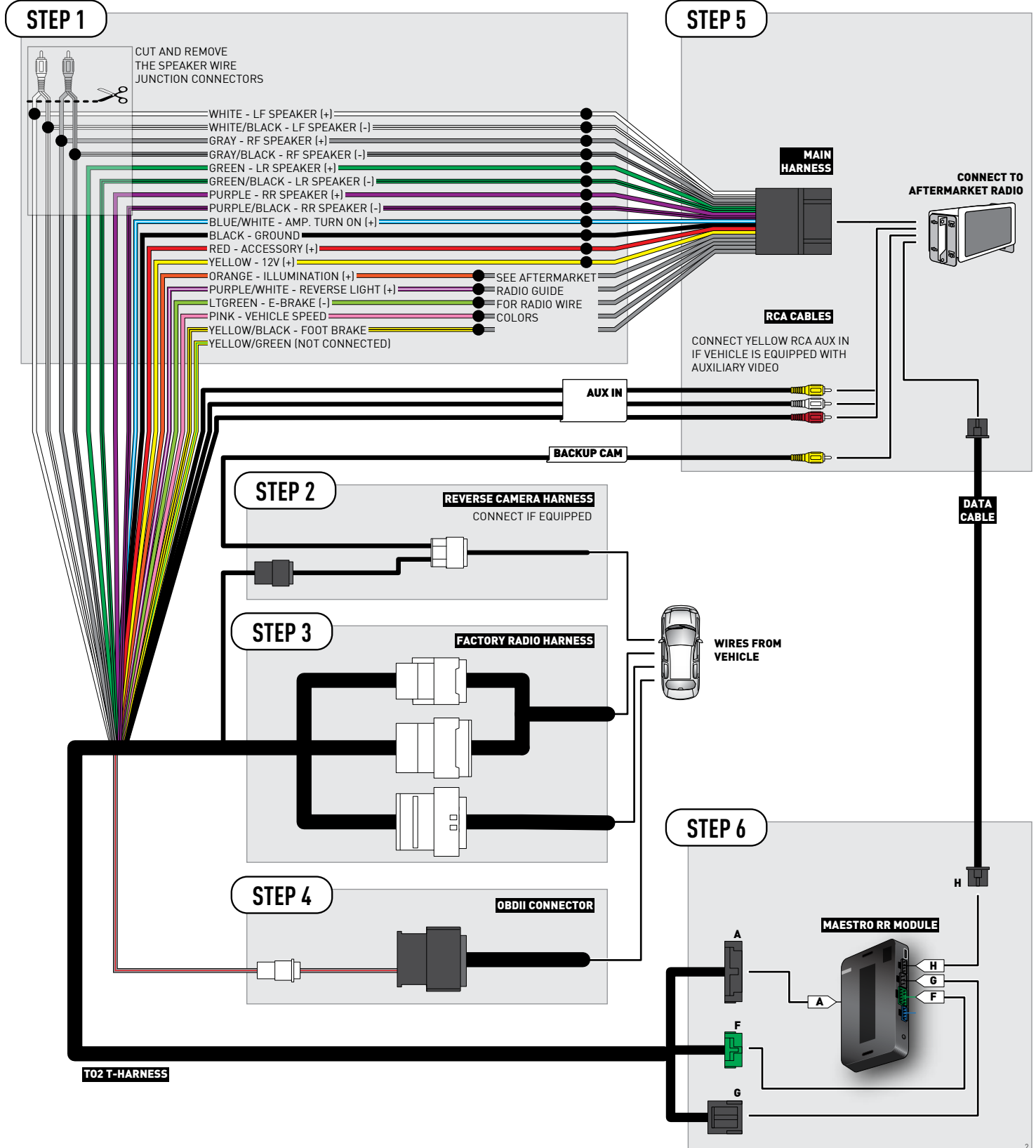

RADIO WIRE REFERENCE CHART

Wire Description	Polarity	Wire Color on Maestro T-Harness	Wire Color on Alpine cable	Wire Color on Kenwood cable	Wire Color on Pioneer cable
Illumination	(+)	Orange	N/A	Orange/White	Orange/White
Reverse Light	(+)	Purple/White or Yellow/Green (see Wiring diagram)	Orange/White	Purple/White	Purple/White
E-Brake	(-)	Lt Green	Yellow/Blue	Lt Green	Lt Green
Foot Brake	(+)	Yellow/Black	Yellow/Black	N/A	N/A
VSS (vehicle speed sensor)	(DATA)	Pink	Green/White	N/A	Pink



INSTALL GUIDE TOYOTA PRIUS C WITH JBL 2015-2018

RETAINS FACTORY AMPLIFIER, STEERING WHEEL CONTROLS, AND MORE!



PRODUCTS REQUIRED

iDatalink Maestro RR Radio Replacement Interface
iDatalink Maestro T02 Installation Harness

OPTIONAL ACCESSORIES

PROGRAMMED FIRMWARE

ADS-RR(SR)-TOY02-DS

NOTICE: Automotive Data Solutions Inc. (ADS) recommends having this installation performed by a certified technician. Logos and trademarks used here in are the properties of their respective owners.

WELCOME

Congratulations on the purchase of your iDatalink Maestro RR Radio replacement solution. You are now a few simple steps away from enjoying your new car radio with enhanced features.

Before starting your installation, please ensure that your iDatalink Maestro module is programmed with the correct firmware and that you carefully review the Installation Diagram and Vehicle Wire Reference Chart.

Please note that Maestro RR will only retain functionalities that were originally available in the vehicle.

NEED HELP?

 **1 866 427-2999**

 **support@idatalink.com**

 **maestro.idatalink.com/support
www.12voltdata.com/forum**

DURING INSTALLATION

Installation Instructions	3
Wiring Diagram	4
Radio Wire Reference Chart	5

INSTALLATION INSTRUCTIONS

STEP 1

- Unbox the aftermarket radio and locate its main harness.
- Connect the wires shown on the next page from aftermarket radio main harness to the T02 T-harness and match the wire functions.
- Remove the factory radio.

STEP 2

- If the vehicle is equipped with an OEM backup camera, connect the T02 T-harness to the backup camera harness.

STEP 3

- Connect the factory harness to the T02 T-harness.

STEP 4

- Plug the male WHITE 2 pin connector of your T02 T-harness into the OBDII harness.
- Plug the OBDII connector into the OBDII of the vehicle.

STEP 5

- Plug the aftermarket radio harnesses into the aftermarket radio.
- Connect the backup camera RCA cable into the aftermarket radio (if equipped).
- Connect the auxiliary RCA cables into the aftermarket radio (if equipped).
- Plug the Data cable to the data port of the aftermarket radio.

STEP 6

- Connect all the harnesses to the Maestro RR module then test your installation.

TROUBLESHOOTING TIPS:

- To reset the module back its factory settings, turn the key to the OFF position then disconnect all connectors from the module. Press and hold the module's programming button and connect all the connectors back to the module. Wait, the module's LED will flash RED rapidly (this may take up to 10 seconds). Release the programming button. Wait, the LED will turn solid GREEN for 2 seconds.
- For technical assistance call 1-866-427-2999 or e-mail "support@idatalink.com". Visit us at "maestro.idatalink.com/support" and "www.12voltdata.com/forum/"

WIRING DIAGRAM *with an Amplifier*

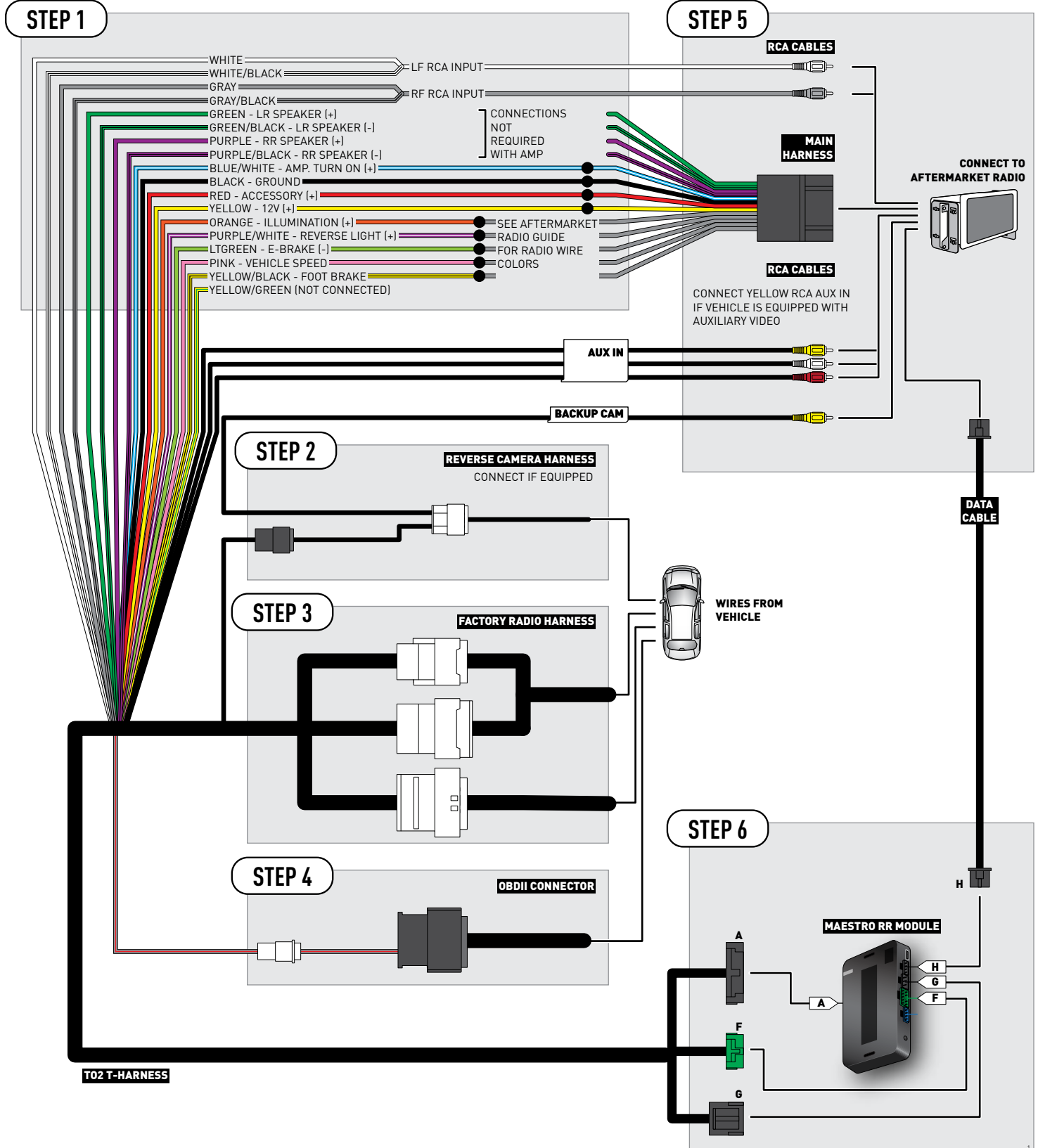

RADIO WIRE REFERENCE CHART

Wire Description	Polarity	Wire Color on Maestro T-Harness	Wire Color on Alpine cable	Wire Color on Kenwood cable	Wire Color on Pioneer cable
Illumination	(+)	Orange	N/A	Orange/White	Orange/White
Reverse Light	(+)	Purple/White or Yellow/Green (see Wiring diagram)	Orange/White	Purple/White	Purple/White
E-Brake	(-)	Lt Green	Yellow/Blue	Lt Green	Lt Green
Foot Brake	(+)	Yellow/Black	Yellow/Black	N/A	N/A
VSS (vehicle speed sensor)	(DATA)	Pink	Green/White	N/A	Pink



INSTALL GUIDE TOYOTA PRIUS C WITHOUT JBL 2012-2014

RETAINS FACTORY AMPLIFIER, STEERING WHEEL CONTROLS, AND MORE!



PRODUCTS REQUIRED

iDatalink Maestro RR Radio Replacement Interface
iDatalink Maestro T02 Installation Harness

OPTIONAL ACCESSORIES

PROGRAMMED FIRMWARE

ADS-RR(SR)-TOY02-DS

NOTICE: Automotive Data Solutions Inc. (ADS) recommends having this installation performed by a certified technician. Logos and trademarks used here in are the properties of their respective owners.

WELCOME

Congratulations on the purchase of your iDatalink Maestro RR Radio replacement solution. You are now a few simple steps away from enjoying your new car radio with enhanced features.

Before starting your installation, please ensure that your iDatalink Maestro module is programmed with the correct firmware and that you carefully review the Installation Diagram and Vehicle Wire Reference Chart.

Please note that Maestro RR will only retain functionalities that were originally available in the vehicle.

NEED HELP?

 **1 866 427-2999**

 **support@idatalink.com**

 **maestro.idatalink.com/support**
www.12voltdata.com/forum

DURING INSTALLATION

Installation Instructions	3
Wiring Diagram	4
Radio Wire Reference Chart	5

INSTALLATION INSTRUCTIONS

STEP 1

- Unbox the aftermarket radio and locate its main harness.
- Cut and remove the front speaker wire junction connectors.
- Connect the wires shown on the next page from aftermarket radio main harness to the T02 T-harness and match the wire functions.
- Remove the factory radio.

STEP 2

- If the vehicle is equipped with an OEM backup camera, connect the T02 T-harness to the backup camera harness.

STEP 3

- Connect the factory harness to the T02 T-harness.

STEP 4

- Plug the male WHITE 2 pin connector of your T02 T-harness into the OBDII harness.
- Plug the OBDII connector into the OBDII of the vehicle.

STEP 5

- Plug the aftermarket radio harnesses into the aftermarket radio.
- Connect the backup camera RCA cable into the aftermarket radio (if equipped).
- Connect the auxiliary RCA cables into the aftermarket radio (if equipped).
- Plug the Data cable to the data port of the aftermarket radio.

STEP 6

- Connect all the harnesses to the Maestro RR module then test your installation.

TROUBLESHOOTING TIPS:

- To reset the module back its factory settings, turn the key to the OFF position then disconnect all connectors from the module. Press and hold the module's programming button and connect all the connectors back to the module. Wait, the module's LED will flash RED rapidly (this may take up to 10 seconds). Release the programming button. Wait, the LED will turn solid GREEN for 2 seconds.
- For technical assistance call 1-866-427-2999 or e-mail "support@idatalink.com". Visit us at "maestro.idatalink.com/support" and "www.12voltdata.com/forum/"

WIRING DIAGRAM *without an Amplifier*

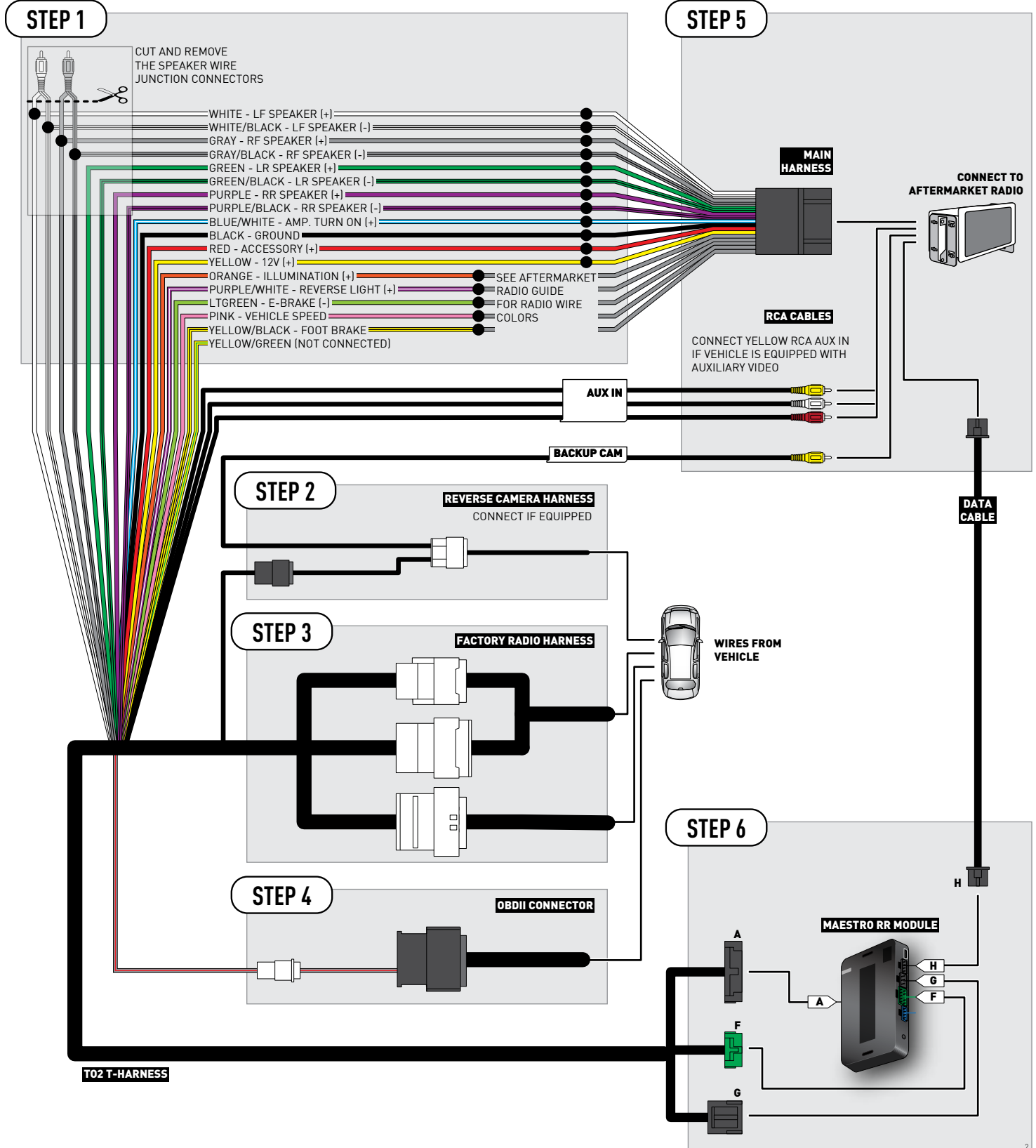

RADIO WIRE REFERENCE CHART

Wire Description	Polarity	Wire Color on Maestro T-Harness	Wire Color on Alpine cable	Wire Color on Kenwood cable	Wire Color on Pioneer cable
Illumination	(+)	Orange	N/A	Orange/White	Orange/White
Reverse Light	(+)	Purple/White or Yellow/Green (see Wiring diagram)	Orange/White	Purple/White	Purple/White
E-Brake	(-)	Lt Green	Yellow/Blue	Lt Green	Lt Green
Foot Brake	(+)	Yellow/Black	Yellow/Black	N/A	N/A
VSS (vehicle speed sensor)	(DATA)	Pink	Green/White	N/A	Pink



INSTALL GUIDE TOYOTA PRIUS C WITHOUT JBL 2015-2018

RETAINS FACTORY AMPLIFIER, STEERING WHEEL CONTROLS, AND MORE!



PRODUCTS REQUIRED

iDatalink Maestro RR Radio Replacement Interface
iDatalink Maestro T02 Installation Harness

OPTIONAL ACCESSORIES

PROGRAMMED FIRMWARE

ADS-RR(SR)-TOY02-DS

NOTICE: Automotive Data Solutions Inc. (ADS) recommends having this installation performed by a certified technician. Logos and trademarks used here in are the properties of their respective owners.

WELCOME

Congratulations on the purchase of your iDatalink Maestro RR Radio replacement solution. You are now a few simple steps away from enjoying your new car radio with enhanced features.

Before starting your installation, please ensure that your iDatalink Maestro module is programmed with the correct firmware and that you carefully review the Installation Diagram and Vehicle Wire Reference Chart.

Please note that Maestro RR will only retain functionalities that were originally available in the vehicle.

NEED HELP?

 **1 866 427-2999**

 **support@idatalink.com**

 **maestro.idatalink.com/support
www.12voltdata.com/forum**

DURING INSTALLATION

Installation Instructions	3
Wiring Diagram	4
Radio Wire Reference Chart	5

INSTALLATION INSTRUCTIONS

STEP 1

- Unbox the aftermarket radio and locate its main harness.
- Cut and remove the front speaker wire junction connectors.
- Connect the wires shown on the next page from aftermarket radio main harness to the T02 T-harness and match the wire functions.
- Remove the factory radio.

STEP 2

- If the vehicle is equipped with an OEM backup camera, connect the T02 T-harness to the backup camera harness.

STEP 3

- Connect the factory harness to the T02 T-harness.

STEP 4

- Plug the male WHITE 2 pin connector of your T02 T-harness into the OBDII harness.
- Plug the OBDII connector into the OBDII of the vehicle.

STEP 5

- Plug the aftermarket radio harnesses into the aftermarket radio.
- Connect the backup camera RCA cable into the aftermarket radio (if equipped).
- Connect the auxiliary RCA cables into the aftermarket radio (if equipped).
- Plug the Data cable to the data port of the aftermarket radio.

STEP 6

- Connect all the harnesses to the Maestro RR module then test your installation.

TROUBLESHOOTING TIPS:

- To reset the module back its factory settings, turn the key to the OFF position then disconnect all connectors from the module. Press and hold the module's programming button and connect all the connectors back to the module. Wait, the module's LED will flash RED rapidly (this may take up to 10 seconds). Release the programming button. Wait, the LED will turn solid GREEN for 2 seconds.
- For technical assistance call 1-866-427-2999 or e-mail "support@idatalink.com". Visit us at "maestro.idatalink.com/support" and "www.12voltdata.com/forum/"

WIRING DIAGRAM *without an Amplifier*

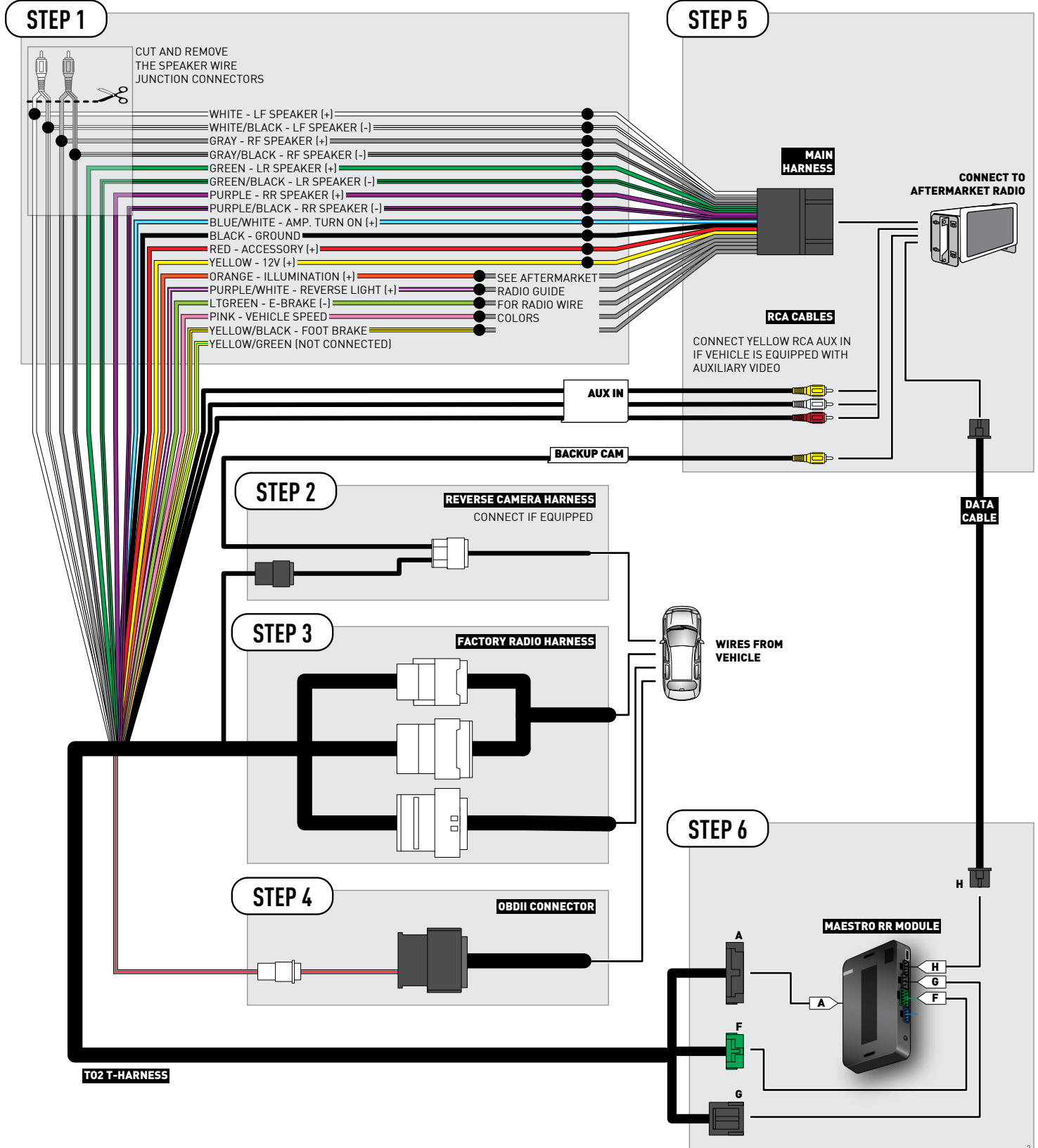

RADIO WIRE REFERENCE CHART

Wire Description	Polarity	Wire Color on Maestro T-Harness	Wire Color on Alpine cable	Wire Color on Kenwood cable	Wire Color on Pioneer cable
Illumination	(+)	Orange	N/A	Orange/White	Orange/White
Reverse Light	(+)	Purple/White or Yellow/Green (see Wiring diagram)	Orange/White	Purple/White	Purple/White
E-Brake	(-)	Lt Green	Yellow/Blue	Lt Green	Lt Green
Foot Brake	(+)	Yellow/Black	Yellow/Black	N/A	N/A
VSS (vehicle speed sensor)	(DATA)	Pink	Green/White	N/A	Pink



INSTALL GUIDE TOYOTA PRIUS V WITH JBL 2012-2014

RETAINS FACTORY AMPLIFIER, STEERING WHEEL CONTROLS, AND MORE!



PRODUCTS REQUIRED

iDatalink Maestro RR Radio Replacement Interface
iDatalink Maestro T02 Installation Harness

OPTIONAL ACCESSORIES

PROGRAMMED FIRMWARE

ADS-RR(SR)-TOY02-DS

NOTICE: Automotive Data Solutions Inc. (ADS) recommends having this installation performed by a certified technician. Logos and trademarks used here in are the properties of their respective owners.

WELCOME

Congratulations on the purchase of your iDatalink Maestro RR Radio replacement solution. You are now a few simple steps away from enjoying your new car radio with enhanced features.

Before starting your installation, please ensure that your iDatalink Maestro module is programmed with the correct firmware and that you carefully review the Installation Diagram and Vehicle Wire Reference Chart.

Please note that Maestro RR will only retain functionalities that were originally available in the vehicle.

NEED HELP?

 **1 866 427-2999**

 **support@idatalink.com**

 **maestro.idatalink.com/support
www.12voltdata.com/forum**

DURING INSTALLATION

Installation Instructions	3
Wiring Diagram	4
Radio Wire Reference Chart	5

INSTALLATION INSTRUCTIONS

STEP 1

- Unbox the aftermarket radio and locate its main harness.
- Connect the wires shown on the next page from aftermarket radio main harness to the T02 T-harness and match the wire functions.
- Remove the factory radio.

STEP 2

- If the vehicle is equipped with an OEM backup camera: Cut the reverse camera plug of the T02 T-harness and connect the wires as indicated in the wiring diagram next page (BROWN/RED and BROWN/YELLOW wires are not used).

STEP 3

- Connect the factory harness to the T02 T-harness.

STEP 4

- Plug the male WHITE 2 pin connector of your T02 T-harness into the OBDII harness.
- Plug the OBDII connector into the OBDII of the vehicle.

STEP 5

- Plug the aftermarket radio harnesses into the aftermarket radio.
- Connect the backup camera RCA cable into the aftermarket radio (if equipped).
- Connect the auxiliary RCA cables into the aftermarket radio (if equipped).
- Plug the Data cable to the data port of the aftermarket radio.

STEP 6

- Connect all the harnesses to the Maestro RR module then test your installation.

TROUBLESHOOTING TIPS:

- To reset the module back its factory settings, turn the key to the OFF position then disconnect all connectors from the module. Press and hold the module's programming button and connect all the connectors back to the module. Wait, the module's LED will flash RED rapidly (this may take up to 10 seconds). Release the programming button. Wait, the LED will turn solid GREEN for 2 seconds.
- For technical assistance call 1-866-427-2999 or e-mail "support@idatalink.com". Visit us at "maestro.idatalink.com/support" and "www.12voltdata.com/forum/"

WIRING DIAGRAM *with an Amplifier*

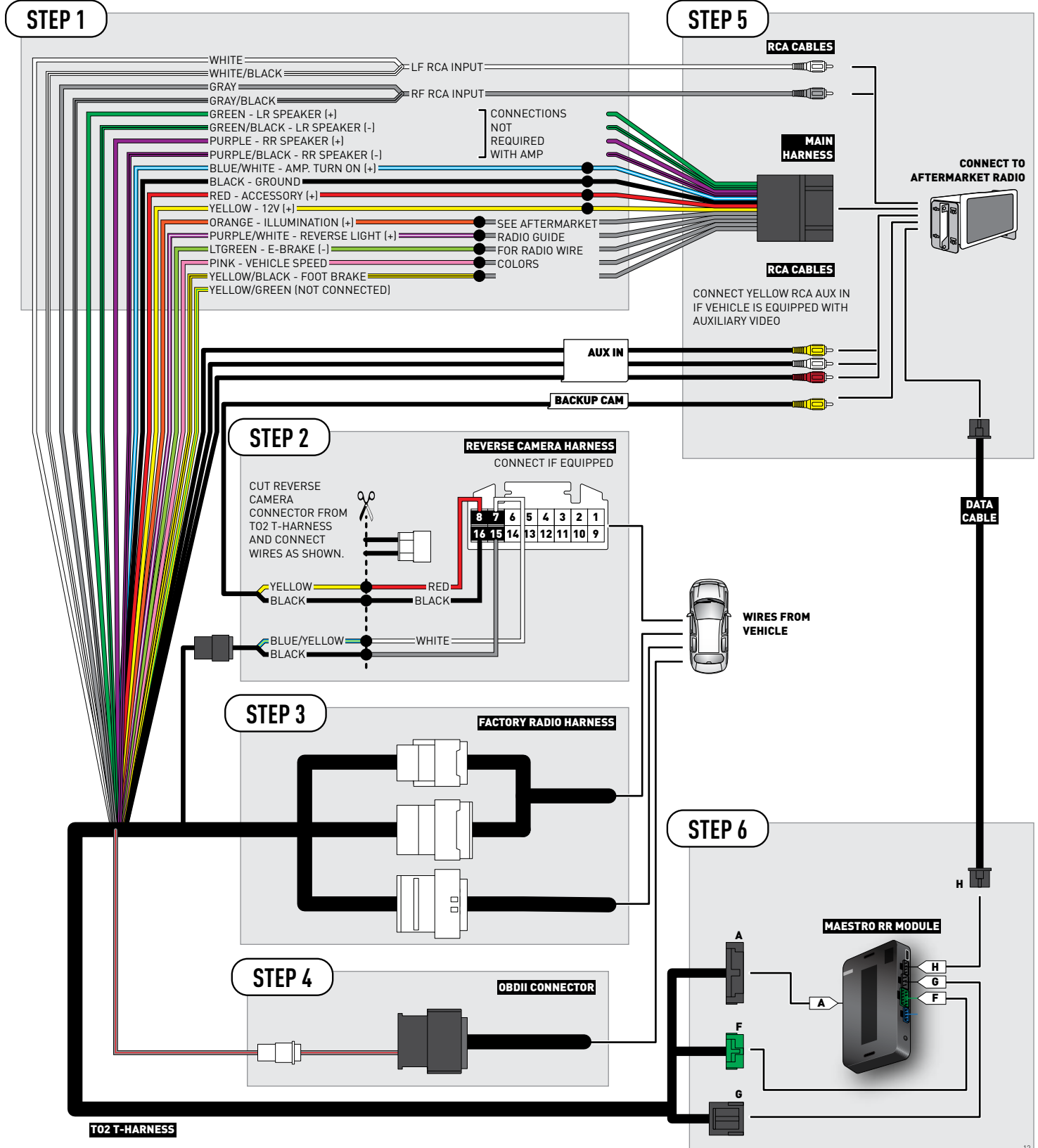

RADIO WIRE REFERENCE CHART

Wire Description	Polarity	Wire Color on Maestro T-Harness	Wire Color on Alpine cable	Wire Color on Kenwood cable	Wire Color on Pioneer cable
Illumination	(+)	Orange	N/A	Orange/White	Orange/White
Reverse Light	(+)	Purple/White or Yellow/Green (see Wiring diagram)	Orange/White	Purple/White	Purple/White
E-Brake	(-)	Lt Green	Yellow/Blue	Lt Green	Lt Green
Foot Brake	(+)	Yellow/Black	Yellow/Black	N/A	N/A
VSS (vehicle speed sensor)	(DATA)	Pink	Green/White	N/A	Pink



INSTALL GUIDE TOYOTA PRIUS V WITH JBL 2015-2017

RETAINS FACTORY AMPLIFIER, STEERING WHEEL CONTROLS, AND MORE!



PRODUCTS REQUIRED

iDatalink Maestro RR Radio Replacement Interface
iDatalink Maestro T02 Installation Harness

OPTIONAL ACCESSORIES

PROGRAMMED FIRMWARE

ADS-RR(SR)-TOY02-DS

NOTICE: Automotive Data Solutions Inc. (ADS) recommends having this installation performed by a certified technician. Logos and trademarks used here in are the properties of their respective owners.

WELCOME

Congratulations on the purchase of your iDatalink Maestro RR Radio replacement solution. You are now a few simple steps away from enjoying your new car radio with enhanced features.

Before starting your installation, please ensure that your iDatalink Maestro module is programmed with the correct firmware and that you carefully review the Installation Diagram and Vehicle Wire Reference Chart.

Please note that Maestro RR will only retain functionalities that were originally available in the vehicle.

NEED HELP?

 **1 866 427-2999**

 support@idatalink.com

 maestro.idatalink.com/support
www.12voltdata.com/forum

DURING INSTALLATION

Installation Instructions	3
Wiring Diagram	4
Radio Wire Reference Chart	5

INSTALLATION INSTRUCTIONS

STEP 1

- Unbox the aftermarket radio and locate its main harness.
- Connect the wires shown on the next page from aftermarket radio main harness to the T02 T-harness and match the wire functions.
- Remove the factory radio.

STEP 2

- If the vehicle is equipped with an OEM backup camera, connect the T02 T-harness to the backup camera harness.

STEP 3

- Connect the factory harness to the T02 T-harness.

STEP 4

- Plug the male WHITE 2 pin connector of your T02 T-harness into the OBDII harness.
- Plug the OBDII connector into the OBDII of the vehicle.

STEP 5

- Plug the aftermarket radio harnesses into the aftermarket radio.
- Connect the backup camera RCA cable into the aftermarket radio (if equipped).
- Connect the auxiliary RCA cables into the aftermarket radio (if equipped).
- Plug the Data cable to the data port of the aftermarket radio.

STEP 6

- Connect all the harnesses to the Maestro RR module then test your installation.

TROUBLESHOOTING TIPS:

- To reset the module back its factory settings, turn the key to the OFF position then disconnect all connectors from the module. Press and hold the module's programming button and connect all the connectors back to the module. Wait, the module's LED will flash RED rapidly (this may take up to 10 seconds). Release the programming button. Wait, the LED will turn solid GREEN for 2 seconds.
- For technical assistance call 1-866-427-2999 or e-mail "support@idatalink.com". Visit us at "maestro.idatalink.com/support" and "www.12voltdata.com/forum/"

WIRING DIAGRAM *with an Amplifier*

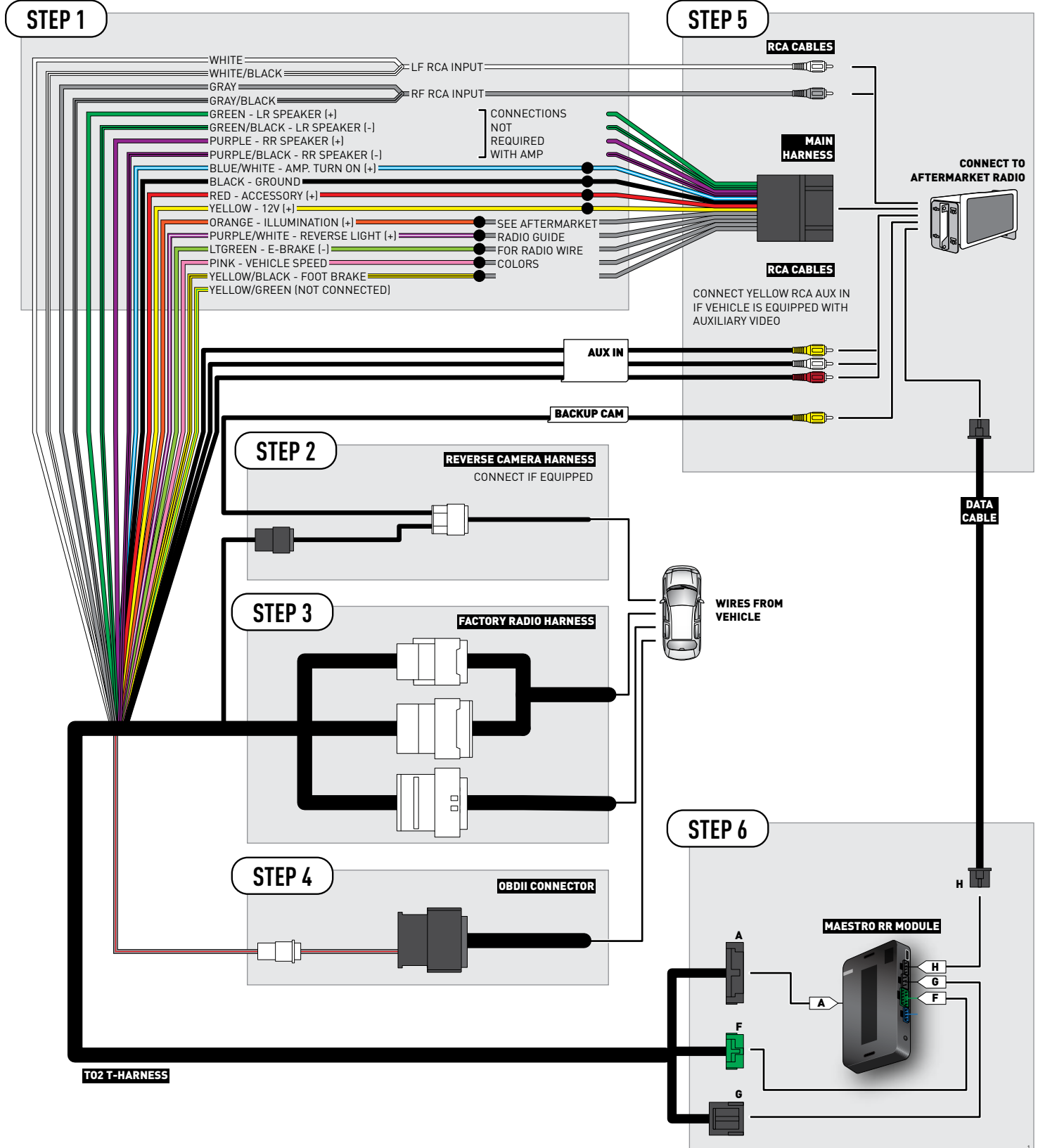

RADIO WIRE REFERENCE CHART

Wire Description	Polarity	Wire Color on Maestro T-Harness	Wire Color on Alpine cable	Wire Color on Kenwood cable	Wire Color on Pioneer cable
Illumination	(+)	Orange	N/A	Orange/White	Orange/White
Reverse Light	(+)	Purple/White or Yellow/Green (see Wiring diagram)	Orange/White	Purple/White	Purple/White
E-Brake	(-)	Lt Green	Yellow/Blue	Lt Green	Lt Green
Foot Brake	(+)	Yellow/Black	Yellow/Black	N/A	N/A
VSS (vehicle speed sensor)	(DATA)	Pink	Green/White	N/A	Pink



INSTALL GUIDE TOYOTA PRIUS V WITHOUT JBL 2012-2014

RETAINS FACTORY AMPLIFIER, STEERING WHEEL CONTROLS, AND MORE!



PRODUCTS REQUIRED

iDatalink Maestro RR Radio Replacement Interface
iDatalink Maestro T02 Installation Harness

OPTIONAL ACCESSORIES

PROGRAMMED FIRMWARE

ADS-RR(SR)-TOY02-DS

NOTICE: Automotive Data Solutions Inc. (ADS) recommends having this installation performed by a certified technician. Logos and trademarks used here in are the properties of their respective owners.

WELCOME

Congratulations on the purchase of your iDatalink Maestro RR Radio replacement solution. You are now a few simple steps away from enjoying your new car radio with enhanced features.

Before starting your installation, please ensure that your iDatalink Maestro module is programmed with the correct firmware and that you carefully review the Installation Diagram and Vehicle Wire Reference Chart.

Please note that Maestro RR will only retain functionalities that were originally available in the vehicle.

NEED HELP?

 **1 866 427-2999**

 **support@idatalink.com**

 **maestro.idatalink.com/support
www.12voltdata.com/forum**

DURING INSTALLATION

Installation Instructions	3
Wiring Diagram	4
Radio Wire Reference Chart	5

INSTALLATION INSTRUCTIONS

STEP 1

- Unbox the aftermarket radio and locate its main harness.
- Cut and remove the front speaker wire junction connectors.
- Connect the wires shown on the next page from aftermarket radio main harness to the T02 T-harness and match the wire functions.
- Remove the factory radio.

STEP 2

- If the vehicle is equipped with an OEM backup camera: Cut the reverse camera plug of the T02 T-harness and connect the wires as indicated in the wiring diagram next page (BROWN/RED and BROWN/YELLOW wires are not used).

STEP 3

- Connect the factory harness to the T02 T-harness.

STEP 4

- Plug the male WHITE 2 pin connector of your T02 T-harness into the OBDII harness.
- Plug the OBDII connector into the OBDII of the vehicle.

STEP 5

- Plug the aftermarket radio harnesses into the aftermarket radio.
- Connect the backup camera RCA cable into the aftermarket radio (if equipped).
- Connect the auxiliary RCA cables into the aftermarket radio (if equipped).
- Plug the Data cable to the data port of the aftermarket radio.

STEP 6

- Connect all the harnesses to the Maestro RR module then test your installation.

TROUBLESHOOTING TIPS:

- To reset the module back its factory settings, turn the key to the OFF position then disconnect all connectors from the module. Press and hold the module's programming button and connect all the connectors back to the module. Wait, the module's LED will flash RED rapidly (this may take up to 10 seconds). Release the programming button. Wait, the LED will turn solid GREEN for 2 seconds.
- For technical assistance call 1-866-427-2999 or e-mail "support@idatalink.com". Visit us at "maestro.idatalink.com/support" and "www.12voltdata.com/forum/"

WIRING DIAGRAM *without an Amplifier*

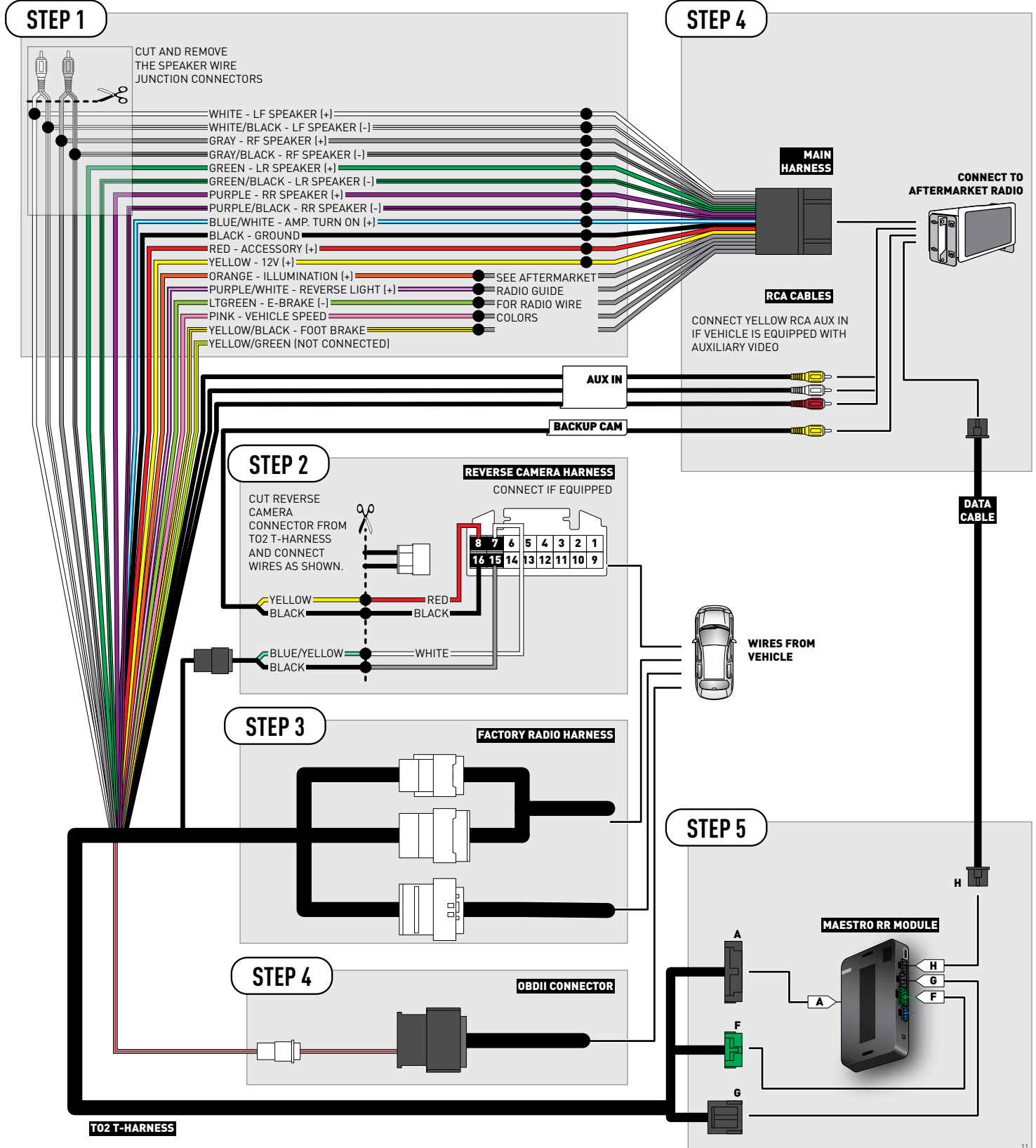

RADIO WIRE REFERENCE CHART

Wire Description	Polarity	Wire Color on Maestro T-Harness	Wire Color on Alpine cable	Wire Color on Kenwood cable	Wire Color on Pioneer cable
Illumination	(+)	Orange	N/A	Orange/White	Orange/White
Reverse Light	(+)	Purple/White or Yellow/Green (see Wiring diagram)	Orange/White	Purple/White	Purple/White
E-Brake	(-)	Lt Green	Yellow/Blue	Lt Green	Lt Green
Foot Brake	(+)	Yellow/Black	Yellow/Black	N/A	N/A
VSS (vehicle speed sensor)	(DATA)	Pink	Green/White	N/A	Pink



INSTALL GUIDE TOYOTA PRIUS V WITHOUT JBL 2015-2017

RETAINS FACTORY AMPLIFIER, STEERING WHEEL CONTROLS, AND MORE!



PRODUCTS REQUIRED

iDatalink Maestro RR Radio Replacement Interface
iDatalink Maestro T02 Installation Harness

OPTIONAL ACCESSORIES

PROGRAMMED FIRMWARE

ADS-RR(SR)-TOY02-DS

NOTICE: Automotive Data Solutions Inc. (ADS) recommends having this installation performed by a certified technician. Logos and trademarks used here in are the properties of their respective owners.

WELCOME

Congratulations on the purchase of your iDatalink Maestro RR Radio replacement solution. You are now a few simple steps away from enjoying your new car radio with enhanced features.

Before starting your installation, please ensure that your iDatalink Maestro module is programmed with the correct firmware and that you carefully review the Installation Diagram and Vehicle Wire Reference Chart.

Please note that Maestro RR will only retain functionalities that were originally available in the vehicle.

NEED HELP?

 **1 866 427-2999**

 **support@idatalink.com**

 **maestro.idatalink.com/support**
www.12voltdata.com/forum

DURING INSTALLATION

Installation Instructions	3
Wiring Diagram	4
Radio Wire Reference Chart	5

INSTALLATION INSTRUCTIONS

STEP 1

- Unbox the aftermarket radio and locate its main harness.
- Cut and remove the front speaker wire junction connectors.
- Connect the wires shown on the next page from aftermarket radio main harness to the T02 T-harness and match the wire functions.
- Remove the factory radio.

STEP 2

- If the vehicle is equipped with an OEM backup camera, connect the T02 T-harness to the backup camera harness.

STEP 3

- Connect the factory harness to the T02 T-harness.

STEP 4

- Plug the male WHITE 2 pin connector of your T02 T-harness into the OBDII harness.
- Plug the OBDII connector into the OBDII of the vehicle.

STEP 5

- Plug the aftermarket radio harnesses into the aftermarket radio.
- Connect the backup camera RCA cable into the aftermarket radio (if equipped).
- Connect the auxiliary RCA cables into the aftermarket radio (if equipped).
- Plug the Data cable to the data port of the aftermarket radio.

STEP 6

- Connect all the harnesses to the Maestro RR module then test your installation.

TROUBLESHOOTING TIPS:

- To reset the module back its factory settings, turn the key to the OFF position then disconnect all connectors from the module. Press and hold the module's programming button and connect all the connectors back to the module. Wait, the module's LED will flash RED rapidly (this may take up to 10 seconds). Release the programming button. Wait, the LED will turn solid GREEN for 2 seconds.
- For technical assistance call 1-866-427-2999 or e-mail "support@idatalink.com". Visit us at "maestro.idatalink.com/support" and "www.12voltdata.com/forum/"

WIRING DIAGRAM *without an Amplifier*

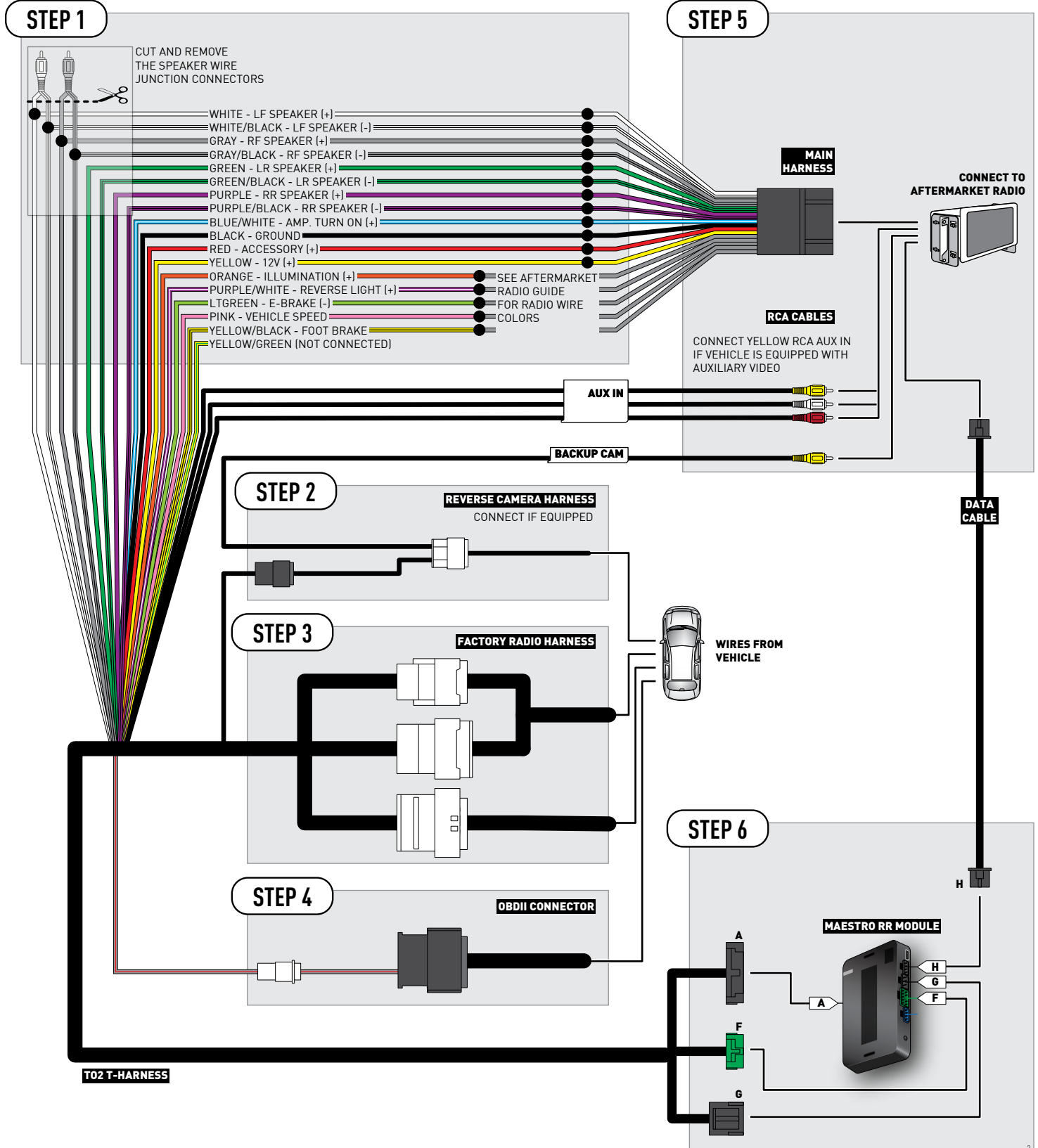

RADIO WIRE REFERENCE CHART

Wire Description	Polarity	Wire Color on Maestro T-Harness	Wire Color on Alpine cable	Wire Color on Kenwood cable	Wire Color on Pioneer cable
Illumination	(+)	Orange	N/A	Orange/White	Orange/White
Reverse Light	(+)	Purple/White or Yellow/Green (see Wiring diagram)	Orange/White	Purple/White	Purple/White
E-Brake	(-)	Lt Green	Yellow/Blue	Lt Green	Lt Green
Foot Brake	(+)	Yellow/Black	Yellow/Black	N/A	N/A
VSS (vehicle speed sensor)	(DATA)	Pink	Green/White	N/A	Pink



INSTALL GUIDE TOYOTA PRIUS WITH JBL 2012-2014

RETAINS FACTORY AMPLIFIER, STEERING WHEEL CONTROLS, AND MORE!



PRODUCTS REQUIRED

iDatalink Maestro RR Radio Replacement Interface
iDatalink Maestro T02 Installation Harness

OPTIONAL ACCESSORIES

PROGRAMMED FIRMWARE

ADS-RR(SR)-TOY02-DS

NOTICE: Automotive Data Solutions Inc. (ADS) recommends having this installation performed by a certified technician. Logos and trademarks used here in are the properties of their respective owners.

WELCOME

Congratulations on the purchase of your iDatalink Maestro RR Radio replacement solution. You are now a few simple steps away from enjoying your new car radio with enhanced features.

Before starting your installation, please ensure that your iDatalink Maestro module is programmed with the correct firmware and that you carefully review the Installation Diagram and Vehicle Wire Reference Chart.

Please note that Maestro RR will only retain functionalities that were originally available in the vehicle.

NEED HELP?

 **1 866 427-2999**

 **support@idatalink.com**

 **maestro.idatalink.com/support
www.12voltdata.com/forum**

DURING INSTALLATION

Installation Instructions	3
Wiring Diagram	4
Radio Wire Reference Chart	5

INSTALLATION INSTRUCTIONS

STEP 1

- Unbox the aftermarket radio and locate its main harness.
- Connect the wires shown on the next page from aftermarket radio main harness to the T02 T-harness and match the wire functions.
- Remove the factory radio.

STEP 2

- If the vehicle is equipped with an OEM backup camera: Cut the reverse camera plug of the T02 T-harness and connect the wires as indicated in the wiring diagram next page (BROWN/RED and BROWN/YELLOW wires are not used).

STEP 3

- Connect the factory harness to the T02 T-harness.

STEP 4

- Plug the male WHITE 2 pin connector of your T02 T-harness into the OBDII harness.
- Plug the OBDII connector into the OBDII of the vehicle.

STEP 5

- Plug the aftermarket radio harnesses into the aftermarket radio.
- Connect the backup camera RCA cable into the aftermarket radio (if equipped).
- Connect the auxiliary RCA cables into the aftermarket radio (if equipped).
- Plug the Data cable to the data port of the aftermarket radio.

STEP 6

- Connect all the harnesses to the Maestro RR module then test your installation.

TROUBLESHOOTING TIPS:

- To reset the module back its factory settings, turn the key to the OFF position then disconnect all connectors from the module. Press and hold the module's programming button and connect all the connectors back to the module. Wait, the module's LED will flash RED rapidly (this may take up to 10 seconds). Release the programming button. Wait, the LED will turn solid GREEN for 2 seconds.
- For technical assistance call 1-866-427-2999 or e-mail "support@idatalink.com". Visit us at "maestro.idatalink.com/support" and "www.12voltdata.com/forum/"

WIRING DIAGRAM *with an Amplifier*

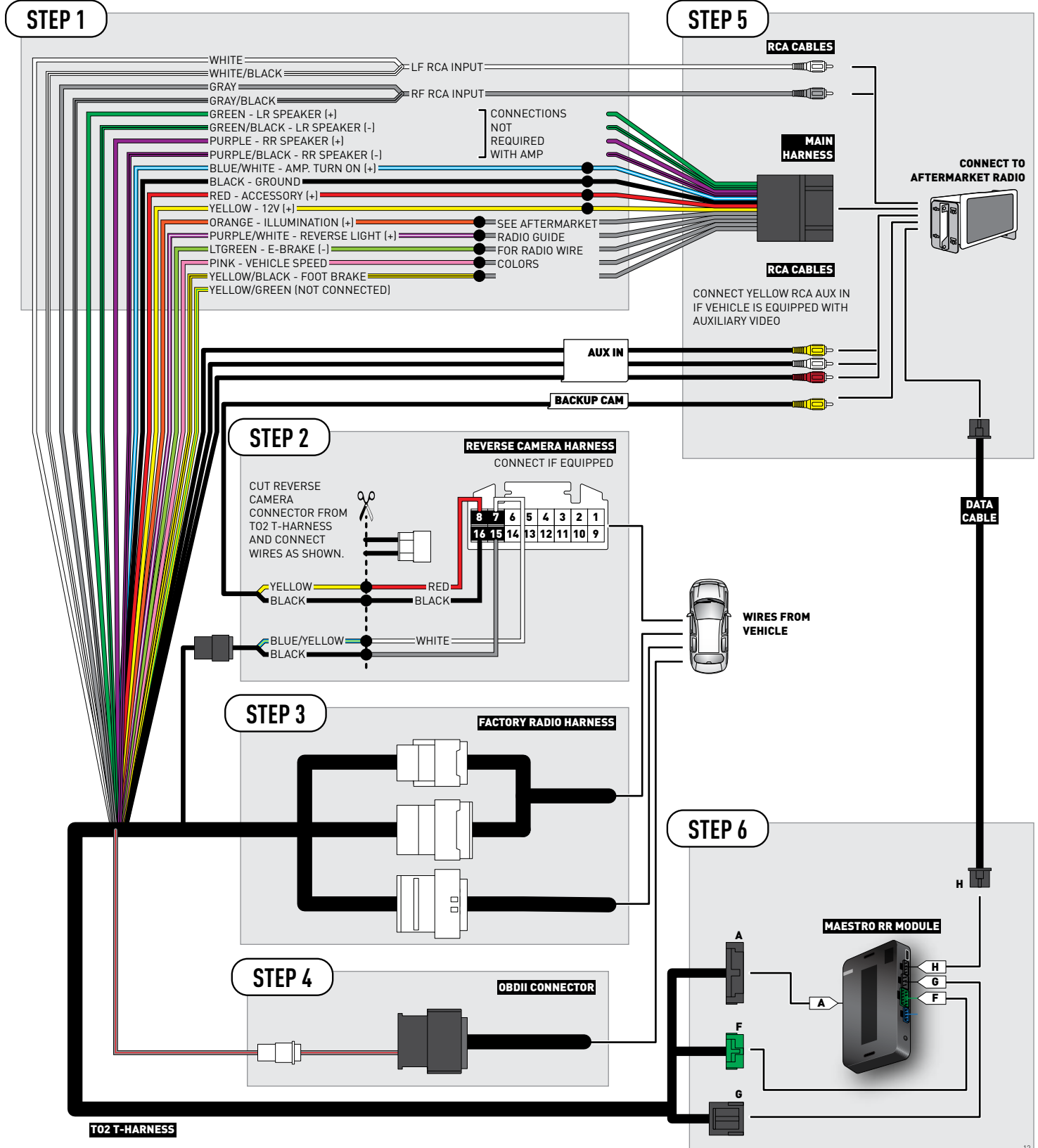

RADIO WIRE REFERENCE CHART

Wire Description	Polarity	Wire Color on Maestro T-Harness	Wire Color on Alpine cable	Wire Color on Kenwood cable	Wire Color on Pioneer cable
Illumination	(+)	Orange	N/A	Orange/White	Orange/White
Reverse Light	(+)	Purple/White or Yellow/Green (see Wiring diagram)	Orange/White	Purple/White	Purple/White
E-Brake	(-)	Lt Green	Yellow/Blue	Lt Green	Lt Green
Foot Brake	(+)	Yellow/Black	Yellow/Black	N/A	N/A
VSS (vehicle speed sensor)	(DATA)	Pink	Green/White	N/A	Pink



INSTALL GUIDE TOYOTA PRIUS WITH JBL 2015-2018

RETAINS FACTORY AMPLIFIER, STEERING WHEEL CONTROLS, AND MORE!



PRODUCTS REQUIRED

iDatalink Maestro RR Radio Replacement Interface
iDatalink Maestro T02 Installation Harness

OPTIONAL ACCESSORIES

PROGRAMMED FIRMWARE

ADS-RR(SR)-TOY02-DS

NOTICE: Automotive Data Solutions Inc. (ADS) recommends having this installation performed by a certified technician. Logos and trademarks used here in are the properties of their respective owners.

WELCOME

Congratulations on the purchase of your iDatalink Maestro RR Radio replacement solution. You are now a few simple steps away from enjoying your new car radio with enhanced features.

Before starting your installation, please ensure that your iDatalink Maestro module is programmed with the correct firmware and that you carefully review the Installation Diagram and Vehicle Wire Reference Chart.

Please note that Maestro RR will only retain functionalities that were originally available in the vehicle.

NEED HELP?

 **1 866 427-2999**

 support@idatalink.com

 maestro.idatalink.com/support
www.12voltdata.com/forum

DURING INSTALLATION

Installation Instructions	3
Wiring Diagram	4
Radio Wire Reference Chart	5

INSTALLATION INSTRUCTIONS

STEP 1

- Unbox the aftermarket radio and locate its main harness.
- Connect the wires shown on the next page from aftermarket radio main harness to the T02 T-harness and match the wire functions.
- Remove the factory radio.

STEP 2

- If the vehicle is equipped with an OEM backup camera, connect the T02 T-harness to the backup camera harness.

STEP 3

- Connect the factory harness to the T02 T-harness.

STEP 4

- Plug the male WHITE 2 pin connector of your T02 T-harness into the OBDII harness.
- Plug the OBDII connector into the OBDII of the vehicle.

STEP 5

- Plug the aftermarket radio harnesses into the aftermarket radio.
- Connect the backup camera RCA cable into the aftermarket radio (if equipped).
- Connect the auxiliary RCA cables into the aftermarket radio (if equipped).
- Plug the Data cable to the data port of the aftermarket radio.

STEP 6

- Connect all the harnesses to the Maestro RR module then test your installation.

TROUBLESHOOTING TIPS:

- To reset the module back its factory settings, turn the key to the OFF position then disconnect all connectors from the module. Press and hold the module's programming button and connect all the connectors back to the module. Wait, the module's LED will flash RED rapidly (this may take up to 10 seconds). Release the programming button. Wait, the LED will turn solid GREEN for 2 seconds.
- For technical assistance call 1-866-427-2999 or e-mail "support@idatalink.com". Visit us at "maestro.idatalink.com/support" and "www.12voltdata.com/forum/"

WIRING DIAGRAM *with an Amplifier*

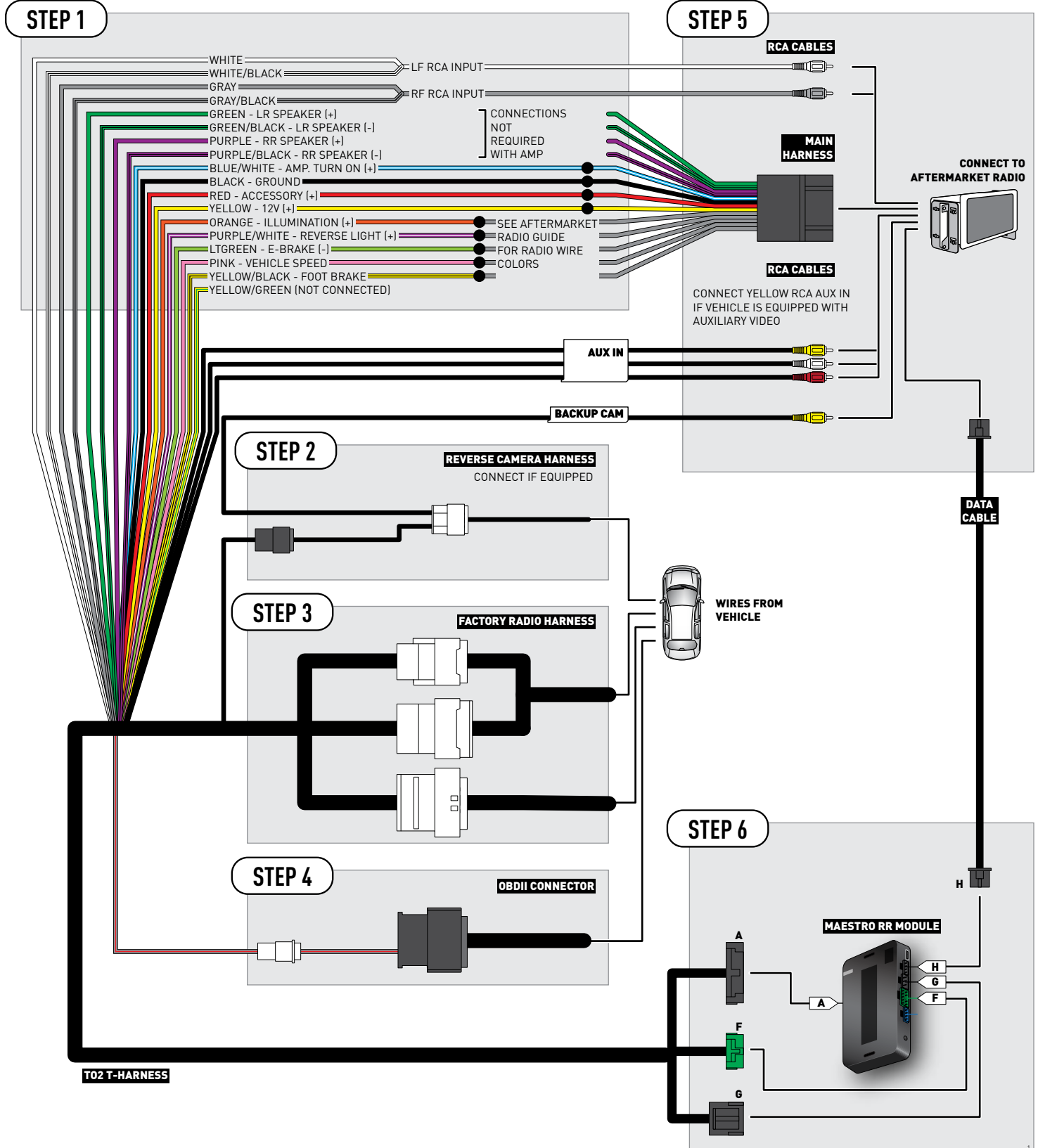

RADIO WIRE REFERENCE CHART

Wire Description	Polarity	Wire Color on Maestro T-Harness	Wire Color on Alpine cable	Wire Color on Kenwood cable	Wire Color on Pioneer cable
Illumination	(+)	Orange	N/A	Orange/White	Orange/White
Reverse Light	(+)	Purple/White or Yellow/Green (see Wiring diagram)	Orange/White	Purple/White	Purple/White
E-Brake	(-)	Lt Green	Yellow/Blue	Lt Green	Lt Green
Foot Brake	(+)	Yellow/Black	Yellow/Black	N/A	N/A
VSS (vehicle speed sensor)	(DATA)	Pink	Green/White	N/A	Pink



INSTALL GUIDE TOYOTA PRIUS WITH NAV WITHOUT JBL 2012-2014

RETAINS FACTORY AMPLIFIER, STEERING WHEEL CONTROLS, AND MORE!



PRODUCTS REQUIRED

iDatalink Maestro RR Radio Replacement Interface
iDatalink Maestro T02 Installation Harness

OPTIONAL ACCESSORIES

PROGRAMMED FIRMWARE

ADS-RR(SR)-TOY02-DS

NOTICE: Automotive Data Solutions Inc. (ADS) recommends having this installation performed by a certified technician. Logos and trademarks used here in are the properties of their respective owners.

WELCOME

Congratulations on the purchase of your iDatalink Maestro RR Radio replacement solution. You are now a few simple steps away from enjoying your new car radio with enhanced features.

Before starting your installation, please ensure that your iDatalink Maestro module is programmed with the correct firmware and that you carefully review the Installation Diagram and Vehicle Wire Reference Chart.

Please note that Maestro RR will only retain functionalities that were originally available in the vehicle.

NEED HELP?

 **1 866 427-2999**

 **support@idatalink.com**

 **maestro.idatalink.com/support
www.12voltdata.com/forum**

DURING INSTALLATION

Installation Instructions	3
Wiring Diagram	4
Radio Wire Reference Chart	5

INSTALLATION INSTRUCTIONS

STEP 1

- Unbox the aftermarket radio and locate its main harness.
- Cut and remove the front speaker wire junction connectors.
- Connect the wires shown on the next page from aftermarket radio main harness to the T02 T-harness and match the wire functions.
- Remove the factory radio.

STEP 2

- If the vehicle is equipped with an OEM backup camera: Cut the reverse camera plug of the T02 T-harness and connect the wires as indicated in the wiring diagram next page (BROWN/RED and BROWN/YELLOW wires are not used).

STEP 3

- Connect the factory harness to the T02 T-harness.

STEP 4

- Plug the male WHITE 2 pin connector of your T02 T-harness into the OBDII harness.
- Plug the OBDII connector into the OBDII of the vehicle.

STEP 5

- Plug the aftermarket radio harnesses into the aftermarket radio.
- Connect the backup camera RCA cable into the aftermarket radio (if equipped).
- Connect the auxiliary RCA cables into the aftermarket radio (if equipped).
- Plug the Data cable to the data port of the aftermarket radio.

STEP 6

- Connect all the harnesses to the Maestro RR module then test your installation.

TROUBLESHOOTING TIPS:

- To reset the module back its factory settings, turn the key to the OFF position then disconnect all connectors from the module. Press and hold the module's programming button and connect all the connectors back to the module. Wait, the module's LED will flash RED rapidly (this may take up to 10 seconds). Release the programming button. Wait, the LED will turn solid GREEN for 2 seconds.
- For technical assistance call 1-866-427-2999 or e-mail "support@idatalink.com". Visit us at "maestro.idatalink.com/support" and "www.12voltdata.com/forum/"

WIRING DIAGRAM *without an Amplifier*

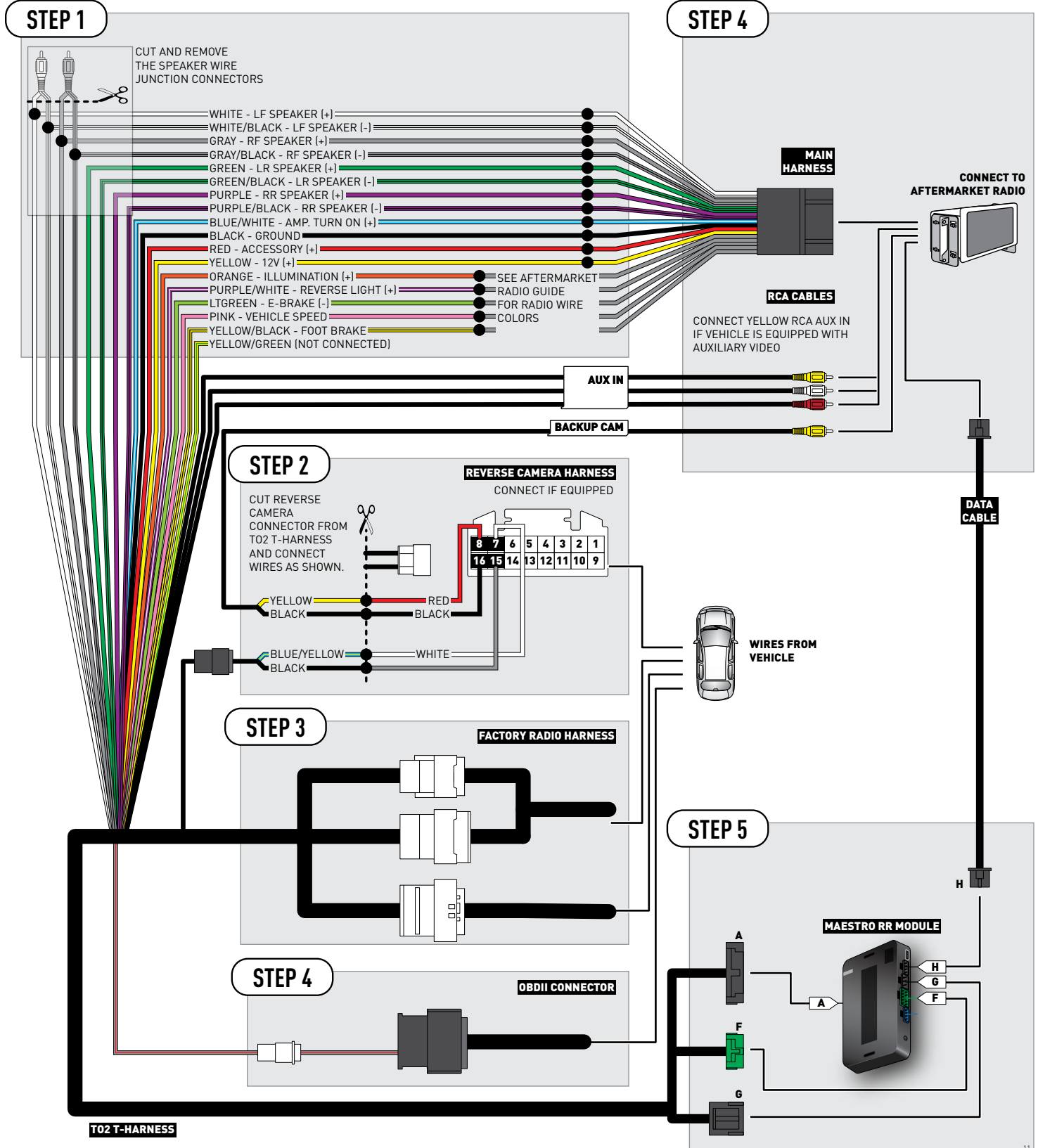

RADIO WIRE REFERENCE CHART

Wire Description	Polarity	Wire Color on Maestro T-Harness	Wire Color on Alpine cable	Wire Color on Kenwood cable	Wire Color on Pioneer cable
Illumination	(+)	Orange	N/A	Orange/White	Orange/White
Reverse Light	(+)	Purple/White or Yellow/Green (see Wiring diagram)	Orange/White	Purple/White	Purple/White
E-Brake	(-)	Lt Green	Yellow/Blue	Lt Green	Lt Green
Foot Brake	(+)	Yellow/Black	Yellow/Black	N/A	N/A
VSS (vehicle speed sensor)	(DATA)	Pink	Green/White	N/A	Pink



INSTALL GUIDE TOYOTA PRIUS WITH NAV WITHOUT JBL 2015-2018

RETAINS FACTORY AMPLIFIER, STEERING WHEEL CONTROLS, AND MORE!



PRODUCTS REQUIRED

iDatalink Maestro RR Radio Replacement Interface
iDatalink Maestro T02 Installation Harness

OPTIONAL ACCESSORIES

PROGRAMMED FIRMWARE

ADS-RR(SR)-TOY02-DS

NOTICE: Automotive Data Solutions Inc. (ADS) recommends having this installation performed by a certified technician. Logos and trademarks used here in are the properties of their respective owners.

WELCOME

Congratulations on the purchase of your iDatalink Maestro RR Radio replacement solution. You are now a few simple steps away from enjoying your new car radio with enhanced features.

Before starting your installation, please ensure that your iDatalink Maestro module is programmed with the correct firmware and that you carefully review the Installation Diagram and Vehicle Wire Reference Chart.

Please note that Maestro RR will only retain functionalities that were originally available in the vehicle.

NEED HELP?

 **1 866 427-2999**

 support@idatalink.com

 maestro.idatalink.com/support
www.12voltdata.com/forum

DURING INSTALLATION

Installation Instructions	3
Wiring Diagram	4
Radio Wire Reference Chart	5

INSTALLATION INSTRUCTIONS

STEP 1

- Unbox the aftermarket radio and locate its main harness.
- Cut and remove the front speaker wire junction connectors.
- Connect the wires shown on the next page from aftermarket radio main harness to the T02 T-harness and match the wire functions.
- Remove the factory radio.

STEP 2

- If the vehicle is equipped with an OEM backup camera, connect the T02 T-harness to the backup camera harness.

STEP 3

- Connect the factory harness to the T02 T-harness.

STEP 4

- Plug the male WHITE 2 pin connector of your T02 T-harness into the OBDII harness.
- Plug the OBDII connector into the OBDII of the vehicle.

STEP 5

- Plug the aftermarket radio harnesses into the aftermarket radio.
- Connect the backup camera RCA cable into the aftermarket radio (if equipped).
- Connect the auxiliary RCA cables into the aftermarket radio (if equipped).
- Plug the Data cable to the data port of the aftermarket radio.

STEP 6

- Connect all the harnesses to the Maestro RR module then test your installation.

TROUBLESHOOTING TIPS:

- To reset the module back its factory settings, turn the key to the OFF position then disconnect all connectors from the module. Press and hold the module's programming button and connect all the connectors back to the module. Wait, the module's LED will flash RED rapidly (this may take up to 10 seconds). Release the programming button. Wait, the LED will turn solid GREEN for 2 seconds.
- For technical assistance call 1-866-427-2999 or e-mail "support@idatalink.com". Visit us at "maestro.idatalink.com/support" and "www.12voltdata.com/forum/"

WIRING DIAGRAM *without an Amplifier*

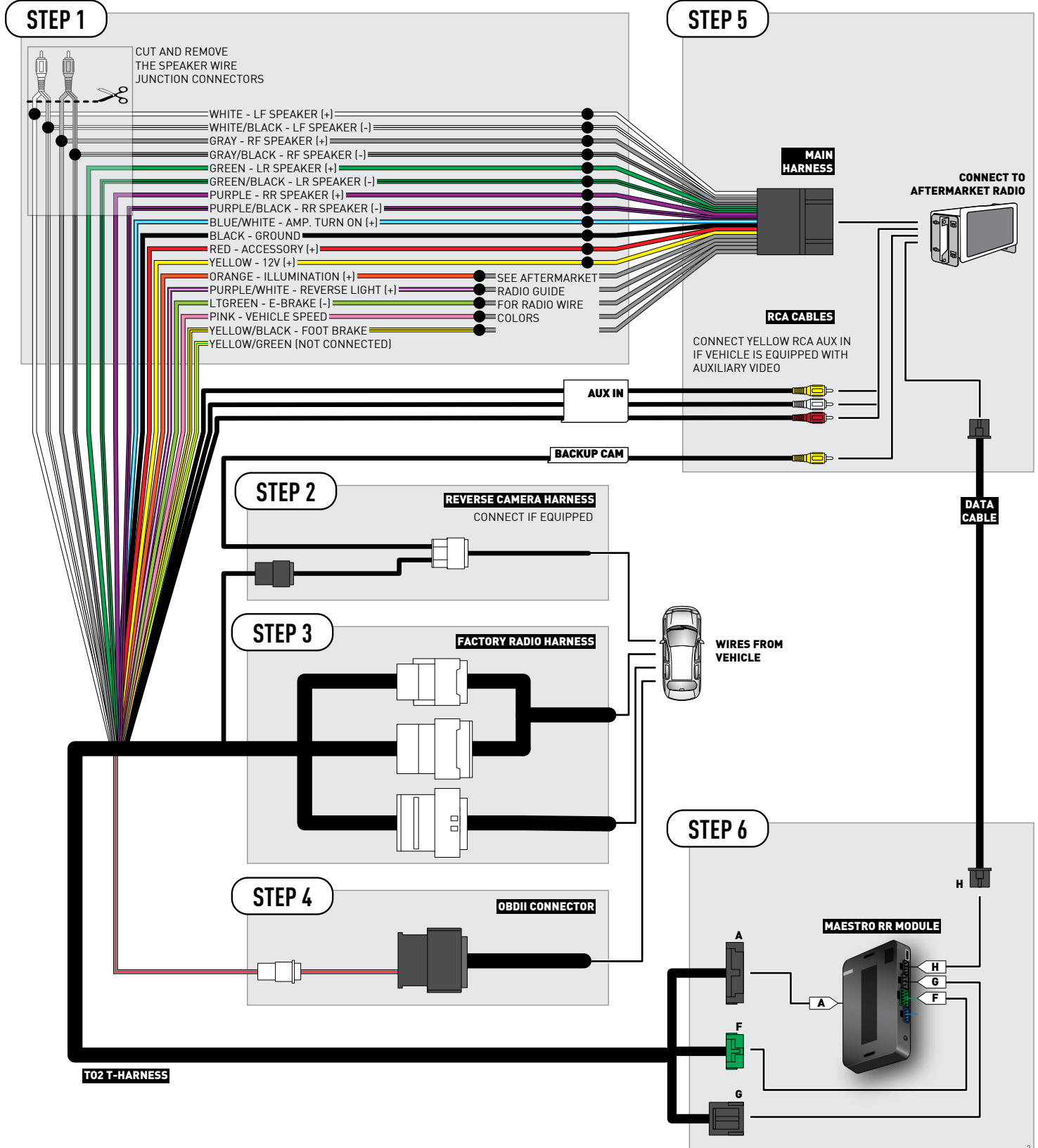

RADIO WIRE REFERENCE CHART

Wire Description	Polarity	Wire Color on Maestro T-Harness	Wire Color on Alpine cable	Wire Color on Kenwood cable	Wire Color on Pioneer cable
Illumination	(+)	Orange	N/A	Orange/White	Orange/White
Reverse Light	(+)	Purple/White or Yellow/Green (see Wiring diagram)	Orange/White	Purple/White	Purple/White
E-Brake	(-)	Lt Green	Yellow/Blue	Lt Green	Lt Green
Foot Brake	(+)	Yellow/Black	Yellow/Black	N/A	N/A
VSS (vehicle speed sensor)	(DATA)	Pink	Green/White	N/A	Pink



INSTALL GUIDE TOYOTA RAV 4 WITH FACTORY 6.1" SCREEN 2013-2018

RETAINS FACTORY AMPLIFIER, STEERING WHEEL CONTROLS, AND MORE!



PRODUCTS REQUIRED

iDatalink Maestro RR Radio Replacement Interface
iDatalink Maestro T02 Installation Harness

OPTIONAL ACCESSORIES

PROGRAMMED FIRMWARE

ADS-RR(SR)-TOY02-DS

NOTICE: Automotive Data Solutions Inc. (ADS) recommends having this installation performed by a certified technician. Logos and trademarks used here in are the properties of their respective owners.

WELCOME

Congratulations on the purchase of your iDatalink Maestro RR Radio replacement solution. You are now a few simple steps away from enjoying your new car radio with enhanced features.

Before starting your installation, please ensure that your iDatalink Maestro module is programmed with the correct firmware and that you carefully review the Installation Diagram and Vehicle Wire Reference Chart.

Please note that Maestro RR will only retain functionalities that were originally available in the vehicle.

NEED HELP?

 **1 866 427-2999**

 **support@idatalink.com**

 **maestro.idatalink.com/support
www.12voltdata.com/forum**

DURING INSTALLATION

Installation Instructions	3
Wiring Diagram	4
Radio Wire Reference Chart	5

INSTALLATION INSTRUCTIONS

STEP 1

- Unbox the aftermarket radio and locate its main harness.
- Cut and remove the front speaker wire junction connectors.
- Connect the wires shown on the next page from aftermarket radio main harness to the T02 T-harness and match the wire functions.
- Remove the factory radio.

STEP 2

- If the vehicle is equipped with an OEM backup camera, connect the T02 T-harness to the backup camera harness.

STEP 3

- Connect the factory harness to the T02 T-harness.

STEP 4

- Plug the aftermarket radio harnesses into the aftermarket radio.
- Connect the backup camera RCA cable into the aftermarket radio (if equipped).
- Connect the auxiliary RCA cables into the aftermarket radio (if equipped).
- Plug the Data cable to the data port of the aftermarket radio.

STEP 5

- Connect all the harnesses to the Maestro RR module then test your installation.

TROUBLESHOOTING TIPS:

- To reset the module back its factory settings, turn the key to the OFF position then disconnect all connectors from the module. Press and hold the module's programming button and connect all the connectors back to the module. Wait, the module's LED will flash RED rapidly (this may take up to 10 seconds). Release the programming button. Wait, the LED will turn solid GREEN for 2 seconds.
- For technical assistance call 1-866-427-2999 or e-mail "support@idatalink.com". Visit us at "maestro.idatalink.com/support" and "www.12voltdata.com/forum/"

WIRING DIAGRAM *without an Amplifier*

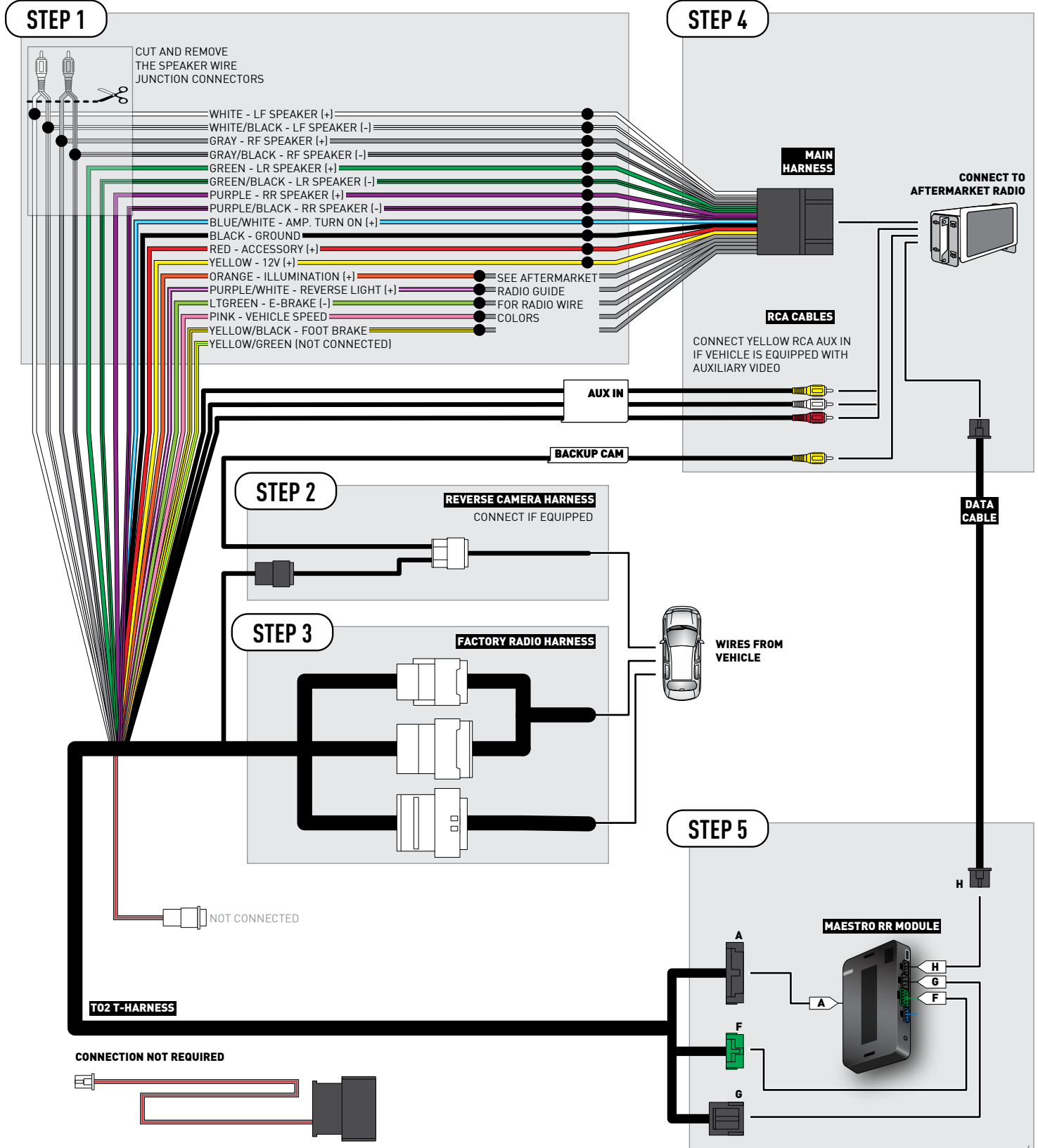

RADIO WIRE REFERENCE CHART

Wire Description	Polarity	Wire Color on Maestro T-Harness	Wire Color on Alpine cable	Wire Color on Kenwood cable	Wire Color on Pioneer cable
Illumination	(+)	Orange	N/A	Orange/White	Orange/White
Reverse Light	(+)	Purple/White or Yellow/Green (see Wiring diagram)	Orange/White	Purple/White	Purple/White
E-Brake	(-)	Lt Green	Yellow/Blue	Lt Green	Lt Green
Foot Brake	(+)	Yellow/Black	Yellow/Black	N/A	N/A
VSS (vehicle speed sensor)	(DATA)	Pink	Green/White	N/A	Pink



INSTALL GUIDE TOYOTA RAV 4 WITH FACTORY 6.1" SCREEN AND JBL 2013-2018

RETAINS FACTORY AMPLIFIER, STEERING WHEEL CONTROLS, AND MORE!



PRODUCTS REQUIRED

iDatalink Maestro RR Radio Replacement Interface
iDatalink Maestro T02 Installation Harness

OPTIONAL ACCESSORIES

PROGRAMMED FIRMWARE

ADS-RR(SR)-TOY02-DS

NOTICE: Automotive Data Solutions Inc. (ADS) recommends having this installation performed by a certified technician. Logos and trademarks used here in are the properties of their respective owners.

WELCOME

Congratulations on the purchase of your iDatalink Maestro RR Radio replacement solution. You are now a few simple steps away from enjoying your new car radio with enhanced features.

Before starting your installation, please ensure that your iDatalink Maestro module is programmed with the correct firmware and that you carefully review the Installation Diagram and Vehicle Wire Reference Chart.

Please note that Maestro RR will only retain functionalities that were originally available in the vehicle.

NEED HELP?

 **1 866 427-2999**

 support@idatalink.com

 maestro.idatalink.com/support
www.12voltdata.com/forum

DURING INSTALLATION

Installation Instructions	3
Wiring Diagram	4
Radio Wire Reference Chart	5

INSTALLATION INSTRUCTIONS

STEP 1

- Unbox the aftermarket radio and locate its main harness.
- Connect the wires shown on the next page from aftermarket radio main harness to the T02 T-harness and match the wire functions.
- Remove the factory radio.

STEP 2

- If the vehicle is equipped with an OEM backup camera, connect the T02 T-harness to the backup camera harness.

STEP 3

- Connect the factory harness to the T02 T-harness.

STEP 4

- Plug the aftermarket radio harnesses into the aftermarket radio.
- Connect the backup camera RCA cable into the aftermarket radio (if equipped).
- Connect the auxiliary RCA cables into the aftermarket radio (if equipped).
- Plug the Data cable to the data port of the aftermarket radio.

STEP 5

- Connect all the harnesses to the Maestro RR module then test your installation.

TROUBLESHOOTING TIPS:

- To reset the module back its factory settings, turn the key to the OFF position then disconnect all connectors from the module. Press and hold the module's programming button and connect all the connectors back to the module. Wait, the module's LED will flash RED rapidly (this may take up to 10 seconds). Release the programming button. Wait, the LED will turn solid GREEN for 2 seconds.
- For technical assistance call 1-866-427-2999 or e-mail "support@idatalink.com". Visit us at "maestro.idatalink.com/support" and "www.12voltdata.com/forum/"

WIRING DIAGRAM *with an Amplifier*

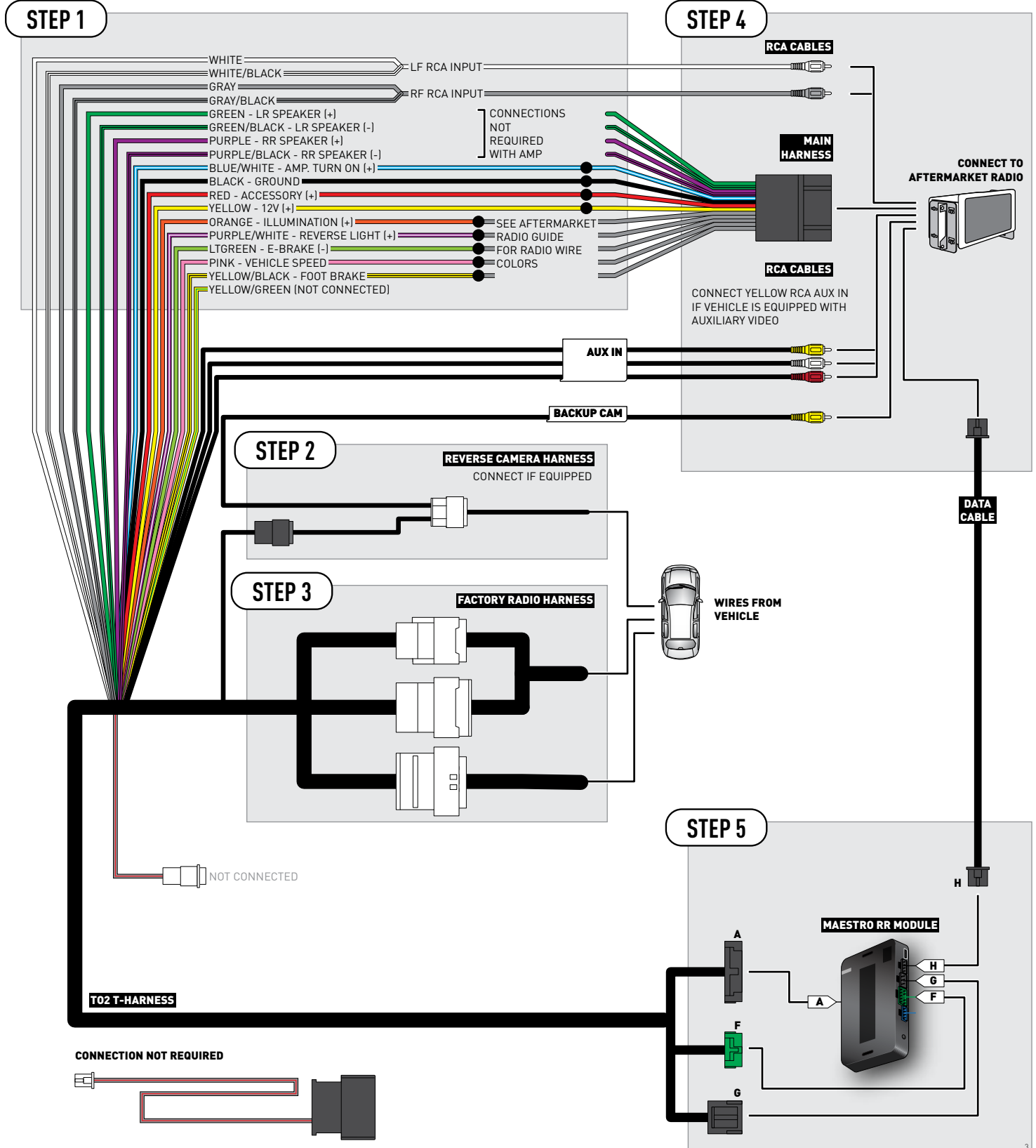

RADIO WIRE REFERENCE CHART

Wire Description	Polarity	Wire Color on Maestro T-Harness	Wire Color on Alpine cable	Wire Color on Kenwood cable	Wire Color on Pioneer cable
Illumination	(+)	Orange	N/A	Orange/White	Orange/White
Reverse Light	(+)	Purple/White or Yellow/Green (see Wiring diagram)	Orange/White	Purple/White	Purple/White
E-Brake	(-)	Lt Green	Yellow/Blue	Lt Green	Lt Green
Foot Brake	(+)	Yellow/Black	Yellow/Black	N/A	N/A
VSS (vehicle speed sensor)	(DATA)	Pink	Green/White	N/A	Pink



INSTALL GUIDE TOYOTA SEQUOIA WITH JBL 2014-2018

RETAINS FACTORY AMPLIFIER, STEERING WHEEL CONTROLS, AND MORE!



PRODUCTS REQUIRED

iDatalink Maestro RR Radio Replacement Interface
iDatalink Maestro T02 Installation Harness

OPTIONAL ACCESSORIES

PROGRAMMED FIRMWARE

ADS-RR(SR)-TOY02-DS

NOTICE: Automotive Data Solutions Inc. (ADS) recommends having this installation performed by a certified technician. Logos and trademarks used here in are the properties of their respective owners.

WELCOME

Congratulations on the purchase of your iDatalink Maestro RR Radio replacement solution. You are now a few simple steps away from enjoying your new car radio with enhanced features.

Before starting your installation, please ensure that your iDatalink Maestro module is programmed with the correct firmware and that you carefully review the Installation Diagram and Vehicle Wire Reference Chart.

Please note that Maestro RR will only retain functionalities that were originally available in the vehicle.

NEED HELP?

 **1 866 427-2999**

 **support@idatalink.com**

 **maestro.idatalink.com/support**
www.12voltdata.com/forum

DURING INSTALLATION

Installation Instructions	3
Wiring Diagram	4
Radio Wire Reference Chart	5

INSTALLATION INSTRUCTIONS

STEP 1

- Unbox the aftermarket radio and locate its main harness.
- Connect the wires shown on the next page from aftermarket radio main harness to the T02 T-harness and match the wire functions.
- Remove the factory radio.

STEP 2

- If the vehicle is equipped with an OEM backup camera, connect the T02 T-harness to the backup camera harness.

STEP 3

- Connect the factory harness to the T02 T-harness.

STEP 4

- Plug the male WHITE 2 pin connector of your T02 T-harness into the OBDII harness.
- Plug the OBDII connector into the OBDII of the vehicle.

STEP 5

- Plug the aftermarket radio harnesses into the aftermarket radio.
- Connect the backup camera RCA cable into the aftermarket radio (if equipped).
- Connect the auxiliary RCA cables into the aftermarket radio (if equipped).
- Plug the Data cable to the data port of the aftermarket radio.

STEP 6

- Connect all the harnesses to the Maestro RR module then test your installation.

TROUBLESHOOTING TIPS:

- To reset the module back its factory settings, turn the key to the OFF position then disconnect all connectors from the module. Press and hold the module's programming button and connect all the connectors back to the module. Wait, the module's LED will flash RED rapidly (this may take up to 10 seconds). Release the programming button. Wait, the LED will turn solid GREEN for 2 seconds.
- For technical assistance call 1-866-427-2999 or e-mail "support@idatalink.com". Visit us at "maestro.idatalink.com/support" and "www.12voltdata.com/forum/"

WIRING DIAGRAM *with an Amplifier*

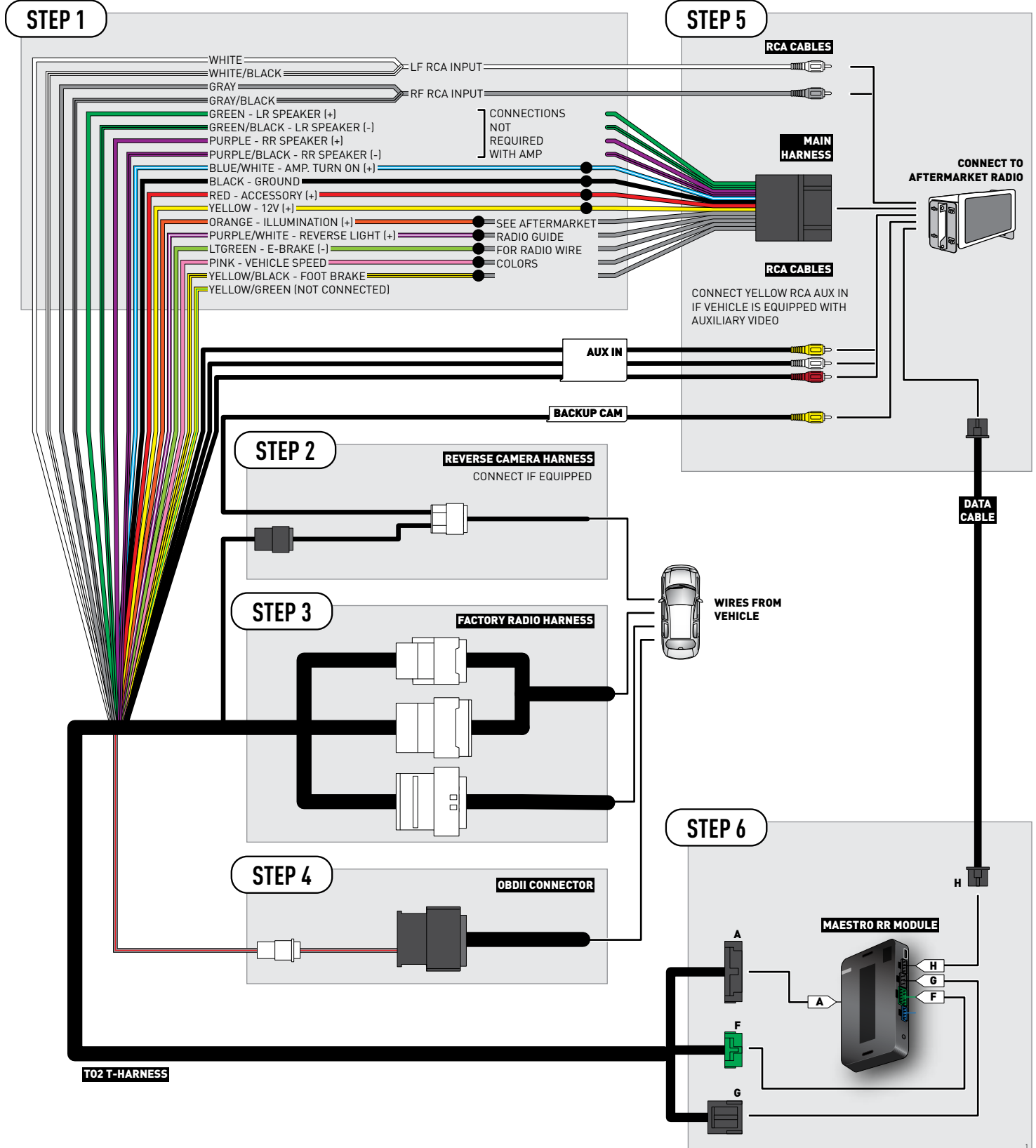

RADIO WIRE REFERENCE CHART

Wire Description	Polarity	Wire Color on Maestro T-Harness	Wire Color on Alpine cable	Wire Color on Kenwood cable	Wire Color on Pioneer cable
Illumination	(+)	Orange	N/A	Orange/White	Orange/White
Reverse Light	(+)	Purple/White or Yellow/Green (see Wiring diagram)	Orange/White	Purple/White	Purple/White
E-Brake	(-)	Lt Green	Yellow/Blue	Lt Green	Lt Green
Foot Brake	(+)	Yellow/Black	Yellow/Black	N/A	N/A
VSS (vehicle speed sensor)	(DATA)	Pink	Green/White	N/A	Pink



INSTALL GUIDE TOYOTA SIENNA WITH JBL 2015-2017

RETAINS FACTORY AMPLIFIER, STEERING WHEEL CONTROLS, AND MORE!



PRODUCTS REQUIRED

iDatalink Maestro RR Radio Replacement Interface
iDatalink Maestro T02 Installation Harness

OPTIONAL ACCESSORIES

PROGRAMMED FIRMWARE

ADS-RR(SR)-TOY02-DS

NOTICE: Automotive Data Solutions Inc. (ADS) recommends having this installation performed by a certified technician. Logos and trademarks used here in are the properties of their respective owners.

WELCOME

Congratulations on the purchase of your iDatalink Maestro RR Radio replacement solution. You are now a few simple steps away from enjoying your new car radio with enhanced features.

Before starting your installation, please ensure that your iDatalink Maestro module is programmed with the correct firmware and that you carefully review the Installation Diagram and Vehicle Wire Reference Chart.

Please note that Maestro RR will only retain functionalities that were originally available in the vehicle.

NEED HELP?

 **1 866 427-2999**

 support@idatalink.com

 maestro.idatalink.com/support
www.12voltdata.com/forum

DURING INSTALLATION

Installation Instructions	3
Wiring Diagram	4
Radio Wire Reference Chart	5

INSTALLATION INSTRUCTIONS

STEP 1

- Unbox the aftermarket radio and locate its main harness.
- Connect the wires shown on the next page from aftermarket radio main harness to the T02 T-harness and match the wire functions.
- Remove the factory radio.

STEP 2

- If the vehicle is equipped with an OEM backup camera, connect the T02 T-harness to the backup camera harness.

Note: The reverse camera cannot be retained in this vehicle.

STEP 3

- Connect the factory harness to the T02 T-harness.

STEP 4

- Plug the male WHITE 2 pin connector of your T02 T-harness into the OBDII harness.
- Plug the OBDII connector into the OBDII of the vehicle.

STEP 5

- Plug the aftermarket radio harnesses into the aftermarket radio.
- Connect the auxiliary RCA cables into the aftermarket radio (if equipped).
- Plug the Data cable to the data port of the aftermarket radio.

STEP 6

- Connect all the harnesses to the Maestro RR module then test your installation.

TROUBLESHOOTING TIPS:

- To reset the module back its factory settings, turn the key to the OFF position then disconnect all connectors from the module. Press and hold the module's programming button and connect all the connectors back to the module. Wait, the module's LED will flash RED rapidly (this may take up to 10 seconds). Release the programming button. Wait, the LED will turn solid GREEN for 2 seconds.
- For technical assistance call 1-866-427-2999 or e-mail "support@idatalink.com". Visit us at "maestro.idatalink.com/support" and "www.12voltdata.com/forum/"

WIRING DIAGRAM *with an Amplifier*

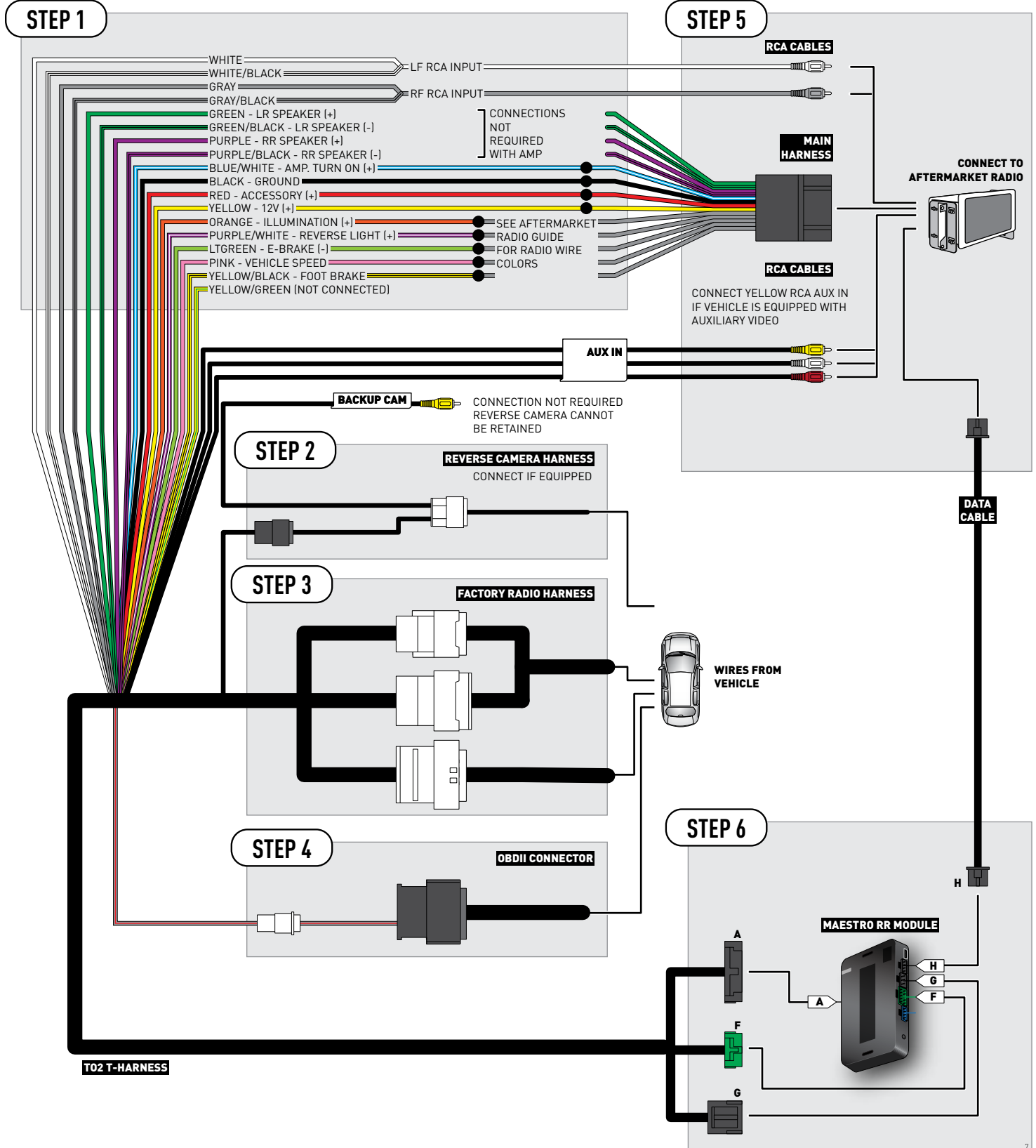

RADIO WIRE REFERENCE CHART

Wire Description	Polarity	Wire Color on Maestro T-Harness	Wire Color on Alpine cable	Wire Color on Kenwood cable	Wire Color on Pioneer cable
Illumination	(+)	Orange	N/A	Orange/White	Orange/White
Reverse Light	(+)	Purple/White or Yellow/Green (see Wiring diagram)	Orange/White	Purple/White	Purple/White
E-Brake	(-)	Lt Green	Yellow/Blue	Lt Green	Lt Green
Foot Brake	(+)	Yellow/Black	Yellow/Black	N/A	N/A
VSS (vehicle speed sensor)	(DATA)	Pink	Green/White	N/A	Pink



INSTALL GUIDE TOYOTA SIENNA WITHOUT JBL 2015-2017

RETAINS FACTORY AMPLIFIER, STEERING WHEEL CONTROLS, AND MORE!



PRODUCTS REQUIRED

iDatalink Maestro RR Radio Replacement Interface
iDatalink Maestro T02 Installation Harness

OPTIONAL ACCESSORIES

PROGRAMMED FIRMWARE

ADS-RR(SR)-TOY02-DS

NOTICE: Automotive Data Solutions Inc. (ADS) recommends having this installation performed by a certified technician. Logos and trademarks used here in are the properties of their respective owners.

WELCOME

Congratulations on the purchase of your iDatalink Maestro RR Radio replacement solution. You are now a few simple steps away from enjoying your new car radio with enhanced features.

Before starting your installation, please ensure that your iDatalink Maestro module is programmed with the correct firmware and that you carefully review the Installation Diagram and Vehicle Wire Reference Chart.

Please note that Maestro RR will only retain functionalities that were originally available in the vehicle.

NEED HELP?

 **1 866 427-2999**

 **support@idatalink.com**

 **maestro.idatalink.com/support
www.12voltdata.com/forum**

DURING INSTALLATION

Installation Instructions	3
Wiring Diagram	4
Radio Wire Reference Chart	5

INSTALLATION INSTRUCTIONS

STEP 1

- Unbox the aftermarket radio and locate its main harness.
- Cut and remove the front speaker wire junction connectors.
- Connect the wires shown on the next page from aftermarket radio main harness to the T02 T-harness and match the wire functions.
- Remove the factory radio.

STEP 2

- If the vehicle is equipped with an OEM backup camera, connect the T02 T-harness to the backup camera harness.

STEP 3

- Connect the factory harness to the T02 T-harness.

STEP 4

- Plug the male WHITE 2 pin connector of your T02 T-harness into the OBDII harness.
- Plug the OBDII connector into the OBDII of the vehicle.

STEP 5

- Plug the aftermarket radio harnesses into the aftermarket radio.
- Connect the backup camera RCA cable into the aftermarket radio (if equipped).
- Connect the auxiliary RCA cables into the aftermarket radio (if equipped).
- Plug the Data cable to the data port of the aftermarket radio.

STEP 6

- Connect all the harnesses to the Maestro RR module then test your installation.

TROUBLESHOOTING TIPS:

- To reset the module back its factory settings, turn the key to the OFF position then disconnect all connectors from the module. Press and hold the module's programming button and connect all the connectors back to the module. Wait, the module's LED will flash RED rapidly (this may take up to 10 seconds). Release the programming button. Wait, the LED will turn solid GREEN for 2 seconds.
- For technical assistance call 1-866-427-2999 or e-mail "support@idatalink.com". Visit us at "maestro.idatalink.com/support" and "www.12voltdata.com/forum/"

WIRING DIAGRAM *without an Amplifier*

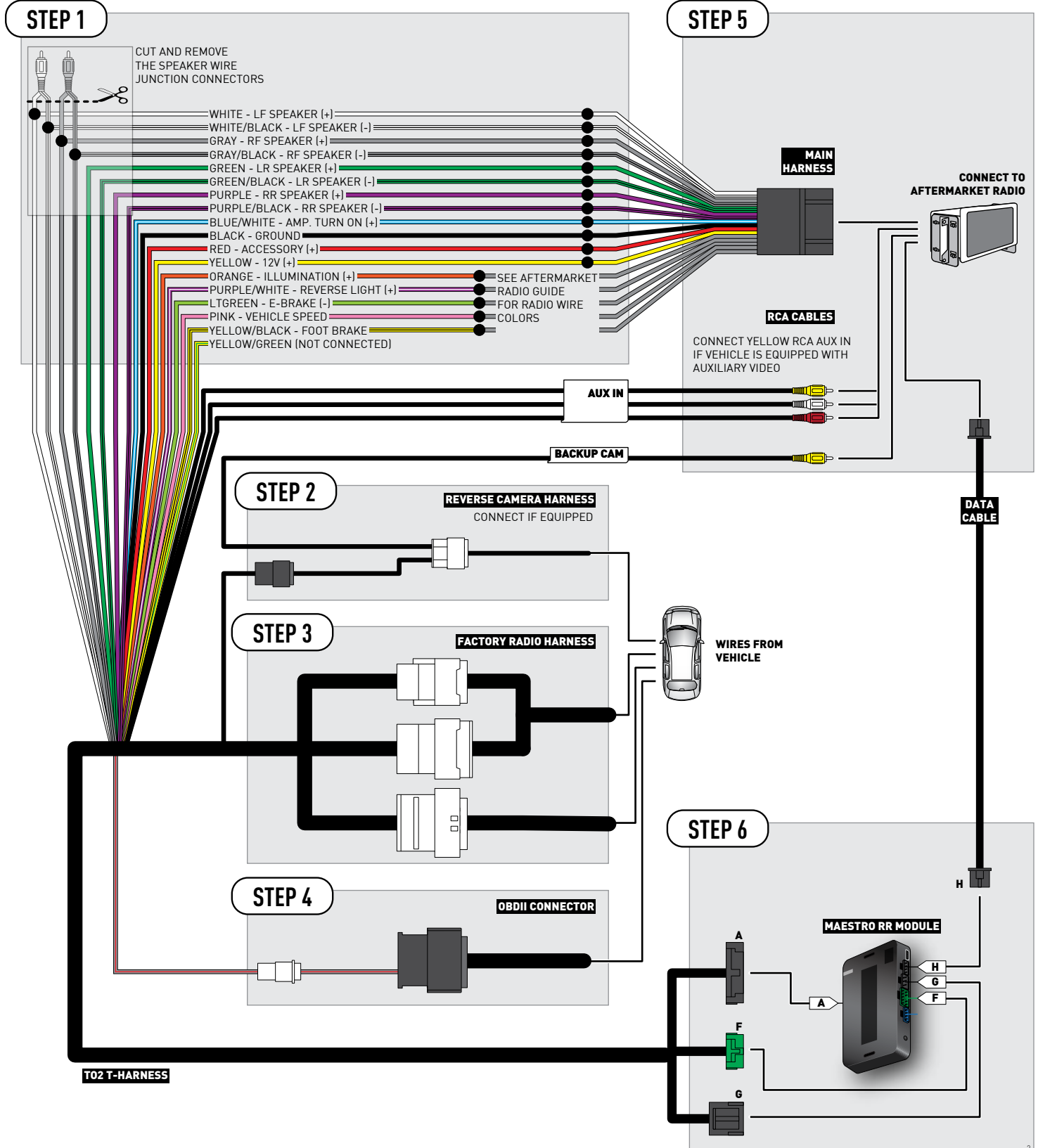

RADIO WIRE REFERENCE CHART

Wire Description	Polarity	Wire Color on Maestro T-Harness	Wire Color on Alpine cable	Wire Color on Kenwood cable	Wire Color on Pioneer cable
Illumination	(+)	Orange	N/A	Orange/White	Orange/White
Reverse Light	(+)	Purple/White or Yellow/Green (see Wiring diagram)	Orange/White	Purple/White	Purple/White
E-Brake	(-)	Lt Green	Yellow/Blue	Lt Green	Lt Green
Foot Brake	(+)	Yellow/Black	Yellow/Black	N/A	N/A
VSS (vehicle speed sensor)	(DATA)	Pink	Green/White	N/A	Pink



INSTALL GUIDE TOYOTA TACOMA WITH JBL 2016-2018

RETAINS FACTORY AMPLIFIER, STEERING WHEEL CONTROLS, AND MORE!



PRODUCTS REQUIRED

iDatalink Maestro RR Radio Replacement Interface
iDatalink Maestro T02 Installation Harness

OPTIONAL ACCESSORIES

PROGRAMMED FIRMWARE

ADS-RR(SR)-TOY02-DS

NOTICE: Automotive Data Solutions Inc. (ADS) recommends having this installation performed by a certified technician. Logos and trademarks used here in are the properties of their respective owners.

WELCOME

Congratulations on the purchase of your iDatalink Maestro RR Radio replacement solution. You are now a few simple steps away from enjoying your new car radio with enhanced features.

Before starting your installation, please ensure that your iDatalink Maestro module is programmed with the correct firmware and that you carefully review the Installation Diagram and Vehicle Wire Reference Chart.

Please note that Maestro RR will only retain functionalities that were originally available in the vehicle.

NEED HELP?

 **1 866 427-2999**

 **support@idatalink.com**

 **maestro.idatalink.com/support
www.12voltdata.com/forum**

DURING INSTALLATION

Installation Instructions	3
Wiring Diagram	4
Radio Wire Reference Chart	5

INSTALLATION INSTRUCTIONS

STEP 1

- Unbox the aftermarket radio and locate its main harness.
- Connect the wires shown on the next page from aftermarket radio main harness to the T02 T-harness and match the wire functions.
- Remove the factory radio.

STEP 2

- If the vehicle is equipped with an OEM backup camera, connect the T02 T-harness to the backup camera harness.

STEP 3

- Connect the factory harness to the T02 T-harness.

STEP 4

- Plug the aftermarket radio harnesses into the aftermarket radio.
- Connect the backup camera RCA cable into the aftermarket radio (if equipped).
- Connect the auxiliary RCA cables into the aftermarket radio (if equipped).
- Plug the Data cable to the data port of the aftermarket radio.

STEP 5

- Connect all the harnesses to the Maestro RR module then test your installation.

TROUBLESHOOTING TIPS:

- To reset the module back its factory settings, turn the key to the OFF position then disconnect all connectors from the module. Press and hold the module's programming button and connect all the connectors back to the module. Wait, the module's LED will flash RED rapidly (this may take up to 10 seconds). Release the programming button. Wait, the LED will turn solid GREEN for 2 seconds.
- For technical assistance call 1-866-427-2999 or e-mail "support@idatalink.com". Visit us at "maestro.idatalink.com/support" and "www.12voltdata.com/forum/"

WIRING DIAGRAM *with an Amplifier*

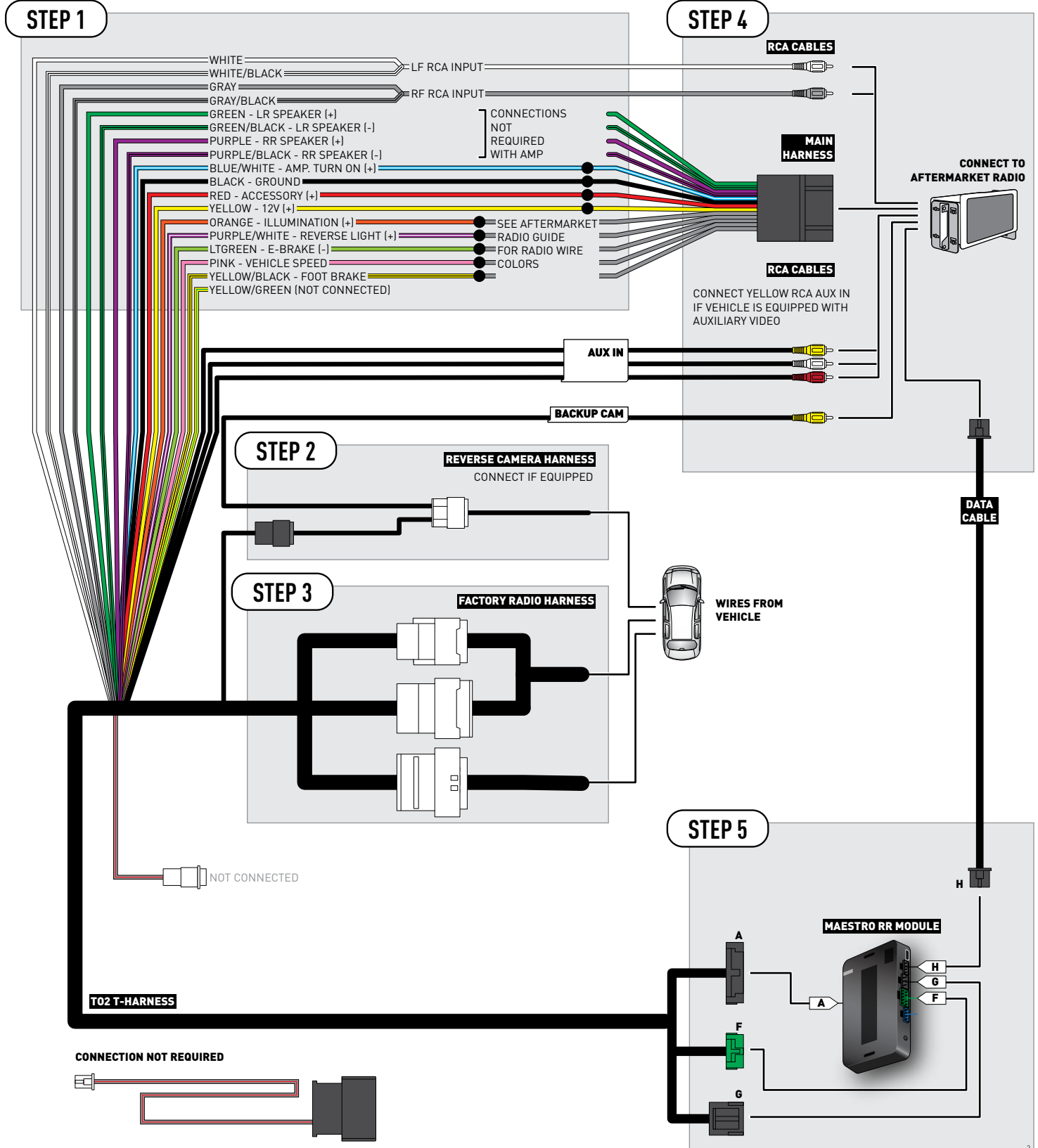

RADIO WIRE REFERENCE CHART

Wire Description	Polarity	Wire Color on Maestro T-Harness	Wire Color on Alpine cable	Wire Color on Kenwood cable	Wire Color on Pioneer cable
Illumination	(+)	Orange	N/A	Orange/White	Orange/White
Reverse Light	(+)	Purple/White or Yellow/Green (see Wiring diagram)	Orange/White	Purple/White	Purple/White
E-Brake	(-)	Lt Green	Yellow/Blue	Lt Green	Lt Green
Foot Brake	(+)	Yellow/Black	Yellow/Black	N/A	N/A
VSS (vehicle speed sensor)	(DATA)	Pink	Green/White	N/A	Pink



INSTALL GUIDE TOYOTA TACOMA WITHOUT JBL 2016-2018

RETAINS FACTORY AMPLIFIER, STEERING WHEEL CONTROLS, AND MORE!



PRODUCTS REQUIRED

iDatalink Maestro RR Radio Replacement Interface
iDatalink Maestro T02 Installation Harness

OPTIONAL ACCESSORIES

PROGRAMMED FIRMWARE

ADS-RR(SR)-TOY02-DS

NOTICE: Automotive Data Solutions Inc. (ADS) recommends having this installation performed by a certified technician. Logos and trademarks used here in are the properties of their respective owners.

WELCOME

Congratulations on the purchase of your iDatalink Maestro RR Radio replacement solution. You are now a few simple steps away from enjoying your new car radio with enhanced features.

Before starting your installation, please ensure that your iDatalink Maestro module is programmed with the correct firmware and that you carefully review the Installation Diagram and Vehicle Wire Reference Chart.

Please note that Maestro RR will only retain functionalities that were originally available in the vehicle.

NEED HELP?

 **1 866 427-2999**

 support@idatalink.com

 maestro.idatalink.com/support
www.12voltdata.com/forum

DURING INSTALLATION

Installation Instructions	3
Wiring Diagram	4
Radio Wire Reference Chart	5

INSTALLATION INSTRUCTIONS

STEP 1

- Unbox the aftermarket radio and locate its main harness.
- Cut and remove the front speaker wire junction connectors.
- Connect the wires shown on the next page from aftermarket radio main harness to the T02 T-harness and match the wire functions.
- Remove the factory radio.

STEP 2

- If the vehicle is equipped with an OEM backup camera, connect the T02 T-harness to the backup camera harness.

STEP 3

- Connect the factory harness to the T02 T-harness.

STEP 4

- Plug the aftermarket radio harnesses into the aftermarket radio.
- Connect the backup camera RCA cable into the aftermarket radio (if equipped).
- Connect the auxiliary RCA cables into the aftermarket radio (if equipped).
- Plug the Data cable to the data port of the aftermarket radio.

STEP 5

- Connect all the harnesses to the Maestro RR module then test your installation.

TROUBLESHOOTING TIPS:

- To reset the module back its factory settings, turn the key to the OFF position then disconnect all connectors from the module. Press and hold the module's programming button and connect all the connectors back to the module. Wait, the module's LED will flash RED rapidly (this may take up to 10 seconds). Release the programming button. Wait, the LED will turn solid GREEN for 2 seconds.
- For technical assistance call 1-866-427-2999 or e-mail "support@idatalink.com". Visit us at "maestro.idatalink.com/support" and "www.12voltdata.com/forum/"

WIRING DIAGRAM *without an Amplifier*

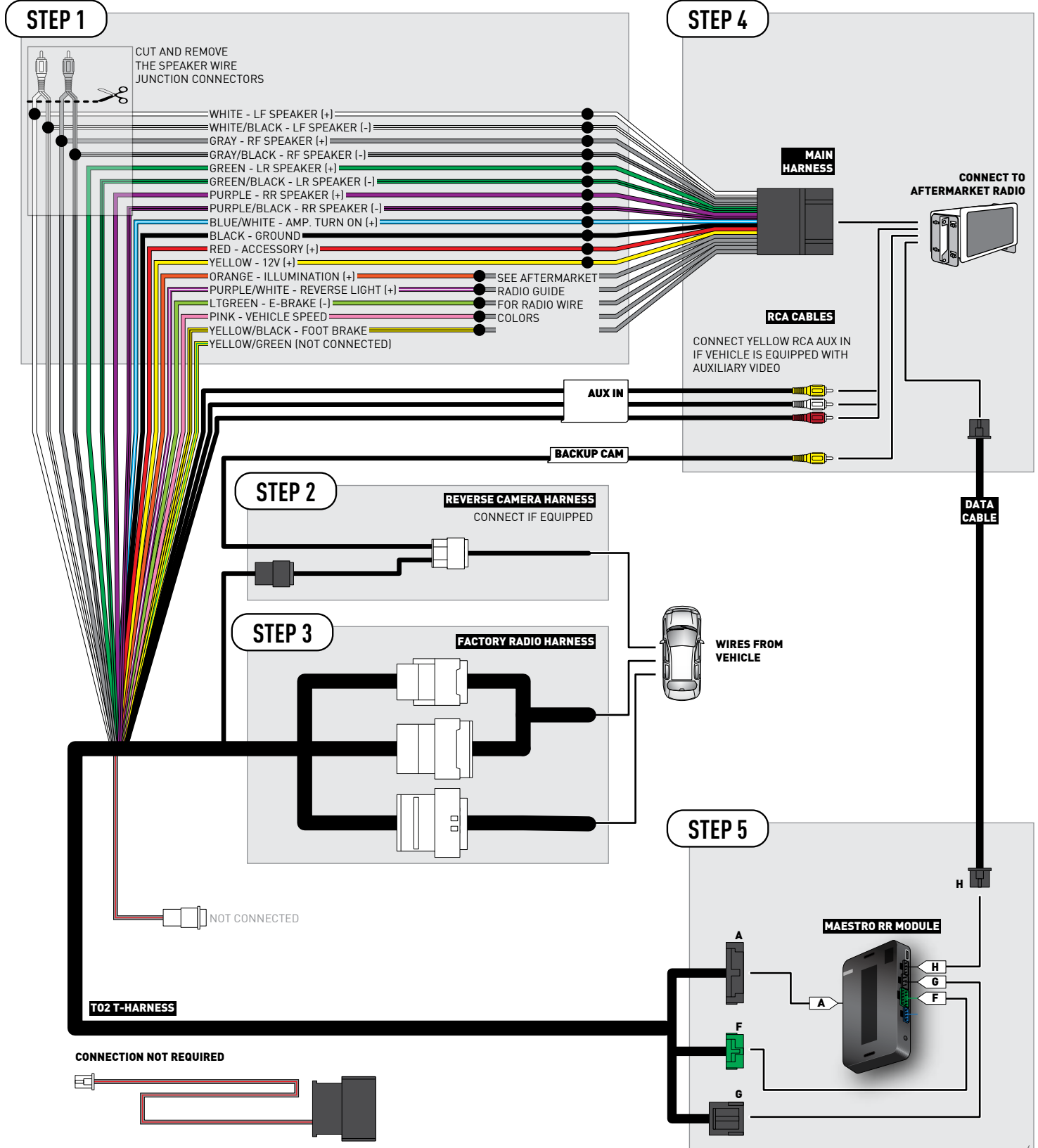

RADIO WIRE REFERENCE CHART

Wire Description	Polarity	Wire Color on Maestro T-Harness	Wire Color on Alpine cable	Wire Color on Kenwood cable	Wire Color on Pioneer cable
Illumination	(+)	Orange	N/A	Orange/White	Orange/White
Reverse Light	(+)	Purple/White or Yellow/Green (see Wiring diagram)	Orange/White	Purple/White	Purple/White
E-Brake	(-)	Lt Green	Yellow/Blue	Lt Green	Lt Green
Foot Brake	(+)	Yellow/Black	Yellow/Black	N/A	N/A
VSS (vehicle speed sensor)	(DATA)	Pink	Green/White	N/A	Pink



INSTALL GUIDE TOYOTA TUNDRA WITH JBL 2014-2018

RETAINS FACTORY AMPLIFIER, STEERING WHEEL CONTROLS, AND MORE!



PRODUCTS REQUIRED

iDatalink Maestro RR Radio Replacement Interface
iDatalink Maestro T02 Installation Harness

OPTIONAL ACCESSORIES

PROGRAMMED FIRMWARE

ADS-RR(SR)-TOY02-DS

NOTICE: Automotive Data Solutions Inc. (ADS) recommends having this installation performed by a certified technician. Logos and trademarks used here in are the properties of their respective owners.

WELCOME

Congratulations on the purchase of your iDatalink Maestro RR Radio replacement solution. You are now a few simple steps away from enjoying your new car radio with enhanced features.

Before starting your installation, please ensure that your iDatalink Maestro module is programmed with the correct firmware and that you carefully review the Installation Diagram and Vehicle Wire Reference Chart.

Please note that Maestro RR will only retain functionalities that were originally available in the vehicle.

NEED HELP?

 **1 866 427-2999**

 support@idatalink.com

 maestro.idatalink.com/support
www.12voltdata.com/forum

DURING INSTALLATION

Installation Instructions	3
Wiring Diagram	4
Radio Wire Reference Chart	5

INSTALLATION INSTRUCTIONS

STEP 1

- Unbox the aftermarket radio and locate its main harness.
- Connect the wires shown on the next page from aftermarket radio main harness to the T02 T-harness and match the wire functions.
- Remove the factory radio.

STEP 2

- If the vehicle is equipped with an OEM backup camera, connect the T02 T-harness to the backup camera harness.

STEP 3

- Connect the factory harness to the T02 T-harness.

STEP 4

- Plug the male WHITE 2 pin connector of your T02 T-harness into the OBDII harness.
- Plug the OBDII connector into the OBDII of the vehicle.

STEP 5

- Plug the aftermarket radio harnesses into the aftermarket radio.
- Connect the backup camera RCA cable into the aftermarket radio (if equipped).
- Connect the auxiliary RCA cables into the aftermarket radio (if equipped).
- Plug the Data cable to the data port of the aftermarket radio.

STEP 6

- Connect all the harnesses to the Maestro RR module then test your installation.

TROUBLESHOOTING TIPS:

- To reset the module back its factory settings, turn the key to the OFF position then disconnect all connectors from the module. Press and hold the module's programming button and connect all the connectors back to the module. Wait, the module's LED will flash RED rapidly (this may take up to 10 seconds). Release the programming button. Wait, the LED will turn solid GREEN for 2 seconds.
- For technical assistance call 1-866-427-2999 or e-mail "support@idatalink.com". Visit us at "maestro.idatalink.com/support" and "www.12voltdata.com/forum/"

WIRING DIAGRAM *with an Amplifier*

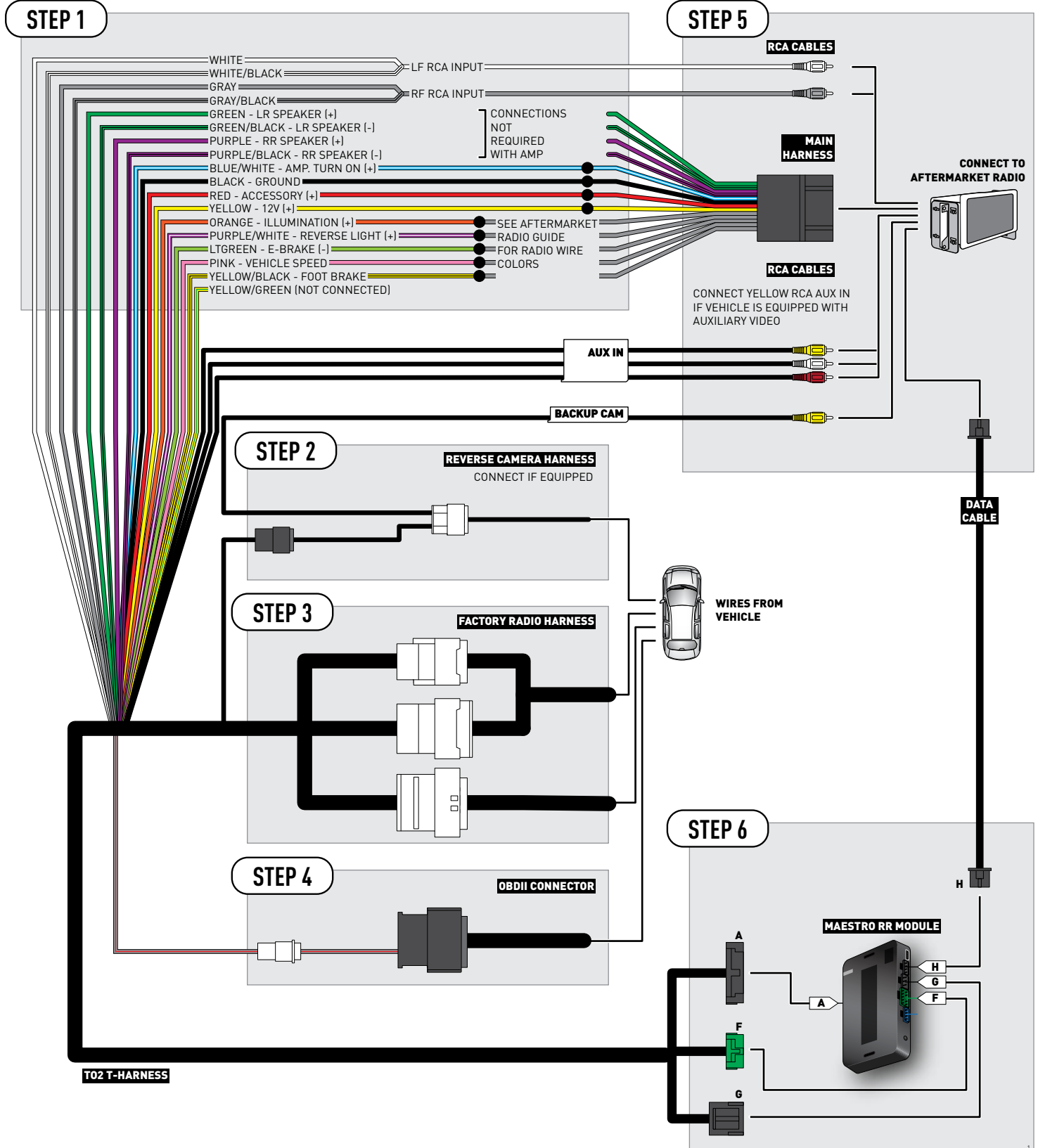

RADIO WIRE REFERENCE CHART

Wire Description	Polarity	Wire Color on Maestro T-Harness	Wire Color on Alpine cable	Wire Color on Kenwood cable	Wire Color on Pioneer cable
Illumination	(+)	Orange	N/A	Orange/White	Orange/White
Reverse Light	(+)	Purple/White or Yellow/Green (see Wiring diagram)	Orange/White	Purple/White	Purple/White
E-Brake	(-)	Lt Green	Yellow/Blue	Lt Green	Lt Green
Foot Brake	(+)	Yellow/Black	Yellow/Black	N/A	N/A
VSS (vehicle speed sensor)	(DATA)	Pink	Green/White	N/A	Pink



INSTALL GUIDE TOYOTA TUNDRA WITHOUT JBL 2014-2018

RETAINS FACTORY AMPLIFIER, STEERING WHEEL CONTROLS, AND MORE!



PRODUCTS REQUIRED

iDatalink Maestro RR Radio Replacement Interface
iDatalink Maestro T02 Installation Harness

OPTIONAL ACCESSORIES

PROGRAMMED FIRMWARE

ADS-RR(SR)-TOY02-DS

NOTICE: Automotive Data Solutions Inc. (ADS) recommends having this installation performed by a certified technician. Logos and trademarks used here in are the properties of their respective owners.

WELCOME

Congratulations on the purchase of your iDatalink Maestro RR Radio replacement solution. You are now a few simple steps away from enjoying your new car radio with enhanced features.

Before starting your installation, please ensure that your iDatalink Maestro module is programmed with the correct firmware and that you carefully review the Installation Diagram and Vehicle Wire Reference Chart.

Please note that Maestro RR will only retain functionalities that were originally available in the vehicle.

NEED HELP?

 **1 866 427-2999**

 support@idatalink.com

 maestro.idatalink.com/support
www.12voltdata.com/forum

DURING INSTALLATION

Installation Instructions	3
Wiring Diagram	4
Radio Wire Reference Chart	5

INSTALLATION INSTRUCTIONS

STEP 1

- Unbox the aftermarket radio and locate its main harness.
- Cut and remove the front speaker wire junction connectors.
- Connect the wires shown on the next page from aftermarket radio main harness to the T02 T-harness and match the wire functions.
- Remove the factory radio.

STEP 2

- If the vehicle is equipped with an OEM backup camera, connect the T02 T-harness to the backup camera harness.

STEP 3

- Connect the factory harness to the T02 T-harness.

STEP 4

- Plug the male WHITE 2 pin connector of your T02 T-harness into the OBDII harness.
- Plug the OBDII connector into the OBDII of the vehicle.

STEP 5

- Plug the aftermarket radio harnesses into the aftermarket radio.
- Connect the backup camera RCA cable into the aftermarket radio (if equipped).
- Connect the auxiliary RCA cables into the aftermarket radio (if equipped).
- Plug the Data cable to the data port of the aftermarket radio.

STEP 6

- Connect all the harnesses to the Maestro RR module then test your installation.

TROUBLESHOOTING TIPS:

- To reset the module back its factory settings, turn the key to the OFF position then disconnect all connectors from the module. Press and hold the module's programming button and connect all the connectors back to the module. Wait, the module's LED will flash RED rapidly (this may take up to 10 seconds). Release the programming button. Wait, the LED will turn solid GREEN for 2 seconds.
- For technical assistance call 1-866-427-2999 or e-mail "support@idatalink.com". Visit us at "maestro.idatalink.com/support" and "www.12voltdata.com/forum/"

WIRING DIAGRAM *without an Amplifier*

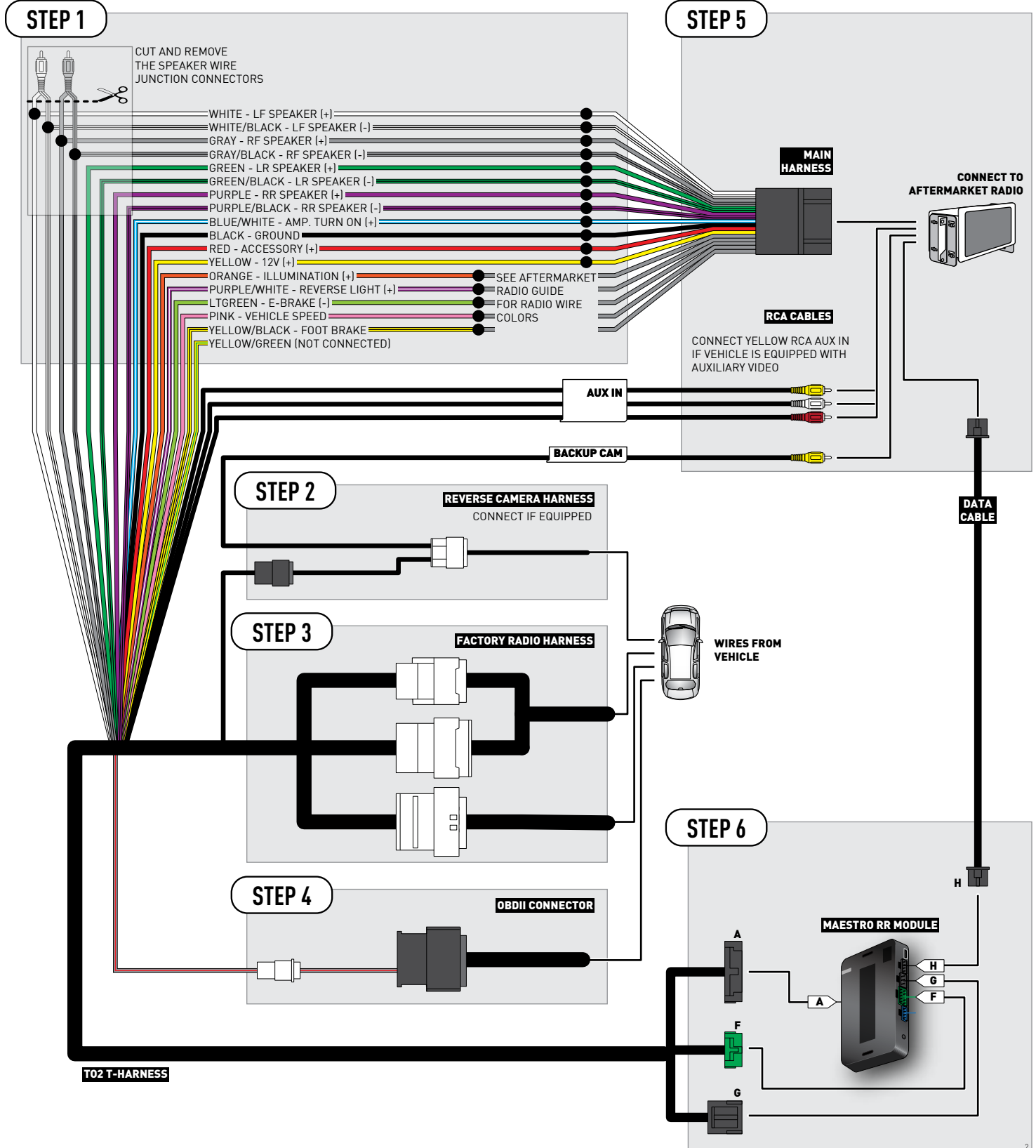

RADIO WIRE REFERENCE CHART

Wire Description	Polarity	Wire Color on Maestro T-Harness	Wire Color on Alpine cable	Wire Color on Kenwood cable	Wire Color on Pioneer cable
Illumination	(+)	Orange	N/A	Orange/White	Orange/White
Reverse Light	(+)	Purple/White or Yellow/Green (see Wiring diagram)	Orange/White	Purple/White	Purple/White
E-Brake	(-)	Lt Green	Yellow/Blue	Lt Green	Lt Green
Foot Brake	(+)	Yellow/Black	Yellow/Black	N/A	N/A
VSS (vehicle speed sensor)	(DATA)	Pink	Green/White	N/A	Pink



INSTALL GUIDE TOYOTA VENZA WITH JBL 2015-2016

RETAINS FACTORY AMPLIFIER, STEERING WHEEL CONTROLS, AND MORE!



PRODUCTS REQUIRED

iDatalink Maestro RR Radio Replacement Interface
iDatalink Maestro T02 Installation Harness

OPTIONAL ACCESSORIES

PROGRAMMED FIRMWARE

ADS-RR(SR)-TOY02-DS

NOTICE: Automotive Data Solutions Inc. (ADS) recommends having this installation performed by a certified technician. Logos and trademarks used here in are the properties of their respective owners.

WELCOME

Congratulations on the purchase of your iDatalink Maestro RR Radio replacement solution. You are now a few simple steps away from enjoying your new car radio with enhanced features.

Before starting your installation, please ensure that your iDatalink Maestro module is programmed with the correct firmware and that you carefully review the Installation Diagram and Vehicle Wire Reference Chart.

Please note that Maestro RR will only retain functionalities that were originally available in the vehicle.

NEED HELP?

 **1 866 427-2999**

 **support@idatalink.com**

 **maestro.idatalink.com/support**
www.12voltdata.com/forum

DURING INSTALLATION

Installation Instructions	3
Wiring Diagram	4
Radio Wire Reference Chart	5

INSTALLATION INSTRUCTIONS

STEP 1

- Unbox the aftermarket radio and locate its main harness.
- Connect the wires shown on the next page from aftermarket radio main harness to the T02 T-harness and match the wire functions.
- Remove the factory radio.

STEP 2

- If the vehicle is equipped with an OEM backup camera, connect the T02 T-harness to the backup camera harness.

STEP 3

- Connect the factory harness to the T02 T-harness.

STEP 4

- Plug the male WHITE 2 pin connector of your T02 T-harness into the OBDII harness.
- Plug the OBDII connector into the OBDII of the vehicle.

STEP 5

- Plug the aftermarket radio harnesses into the aftermarket radio.
- Connect the backup camera RCA cable into the aftermarket radio (if equipped).
- Connect the auxiliary RCA cables into the aftermarket radio (if equipped).
- Plug the Data cable to the data port of the aftermarket radio.

STEP 6

- Connect all the harnesses to the Maestro RR module then test your installation.

TROUBLESHOOTING TIPS:

- To reset the module back its factory settings, turn the key to the OFF position then disconnect all connectors from the module. Press and hold the module's programming button and connect all the connectors back to the module. Wait, the module's LED will flash RED rapidly (this may take up to 10 seconds). Release the programming button. Wait, the LED will turn solid GREEN for 2 seconds.
- For technical assistance call 1-866-427-2999 or e-mail "support@idatalink.com". Visit us at "maestro.idatalink.com/support" and "www.12voltdata.com/forum/"

WIRING DIAGRAM *with an Amplifier*

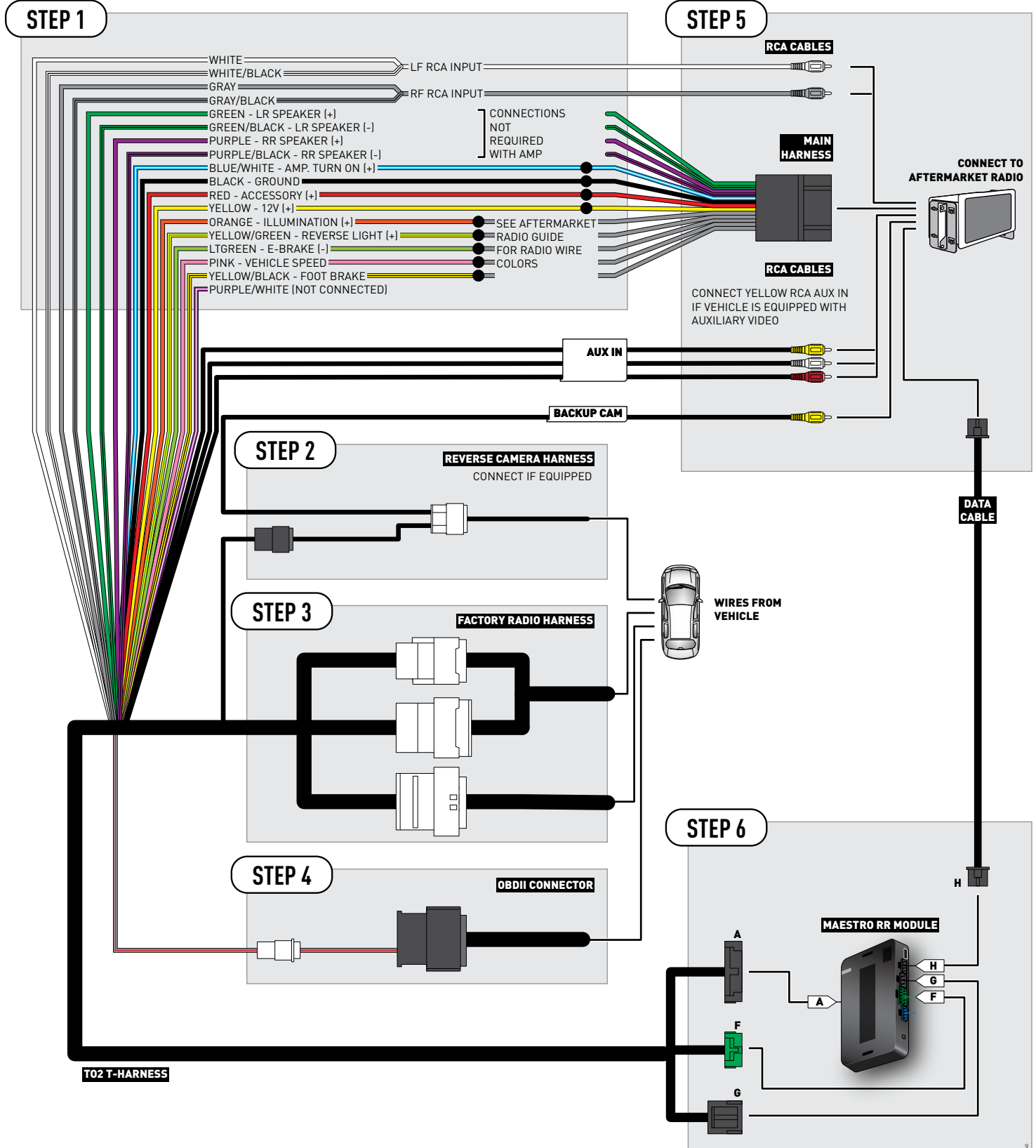

RADIO WIRE REFERENCE CHART

Wire Description	Polarity	Wire Color on Maestro T-Harness	Wire Color on Alpine cable	Wire Color on Kenwood cable	Wire Color on Pioneer cable
Illumination	(+)	Orange	N/A	Orange/White	Orange/White
Reverse Light	(+)	Purple/White or Yellow/Green (see Wiring diagram)	Orange/White	Purple/White	Purple/White
E-Brake	(-)	Lt Green	Yellow/Blue	Lt Green	Lt Green
Foot Brake	(+)	Yellow/Black	Yellow/Black	N/A	N/A
VSS (vehicle speed sensor)	(DATA)	Pink	Green/White	N/A	Pink



INSTALL GUIDE TOYOTA VENZA WITH JBL AND NAV 2013-2014

RETAINS FACTORY AMPLIFIER, STEERING WHEEL CONTROLS, AND MORE!



PRODUCTS REQUIRED

iDatalink Maestro RR Radio Replacement Interface
iDatalink Maestro T02 Installation Harness

OPTIONAL ACCESSORIES

PROGRAMMED FIRMWARE

ADS-RR(SR)-TOY02-DS

NOTICE: Automotive Data Solutions Inc. (ADS) recommends having this installation performed by a certified technician. Logos and trademarks used here in are the properties of their respective owners.

WELCOME

Congratulations on the purchase of your iDatalink Maestro RR Radio replacement solution. You are now a few simple steps away from enjoying your new car radio with enhanced features.

Before starting your installation, please ensure that your iDatalink Maestro module is programmed with the correct firmware and that you carefully review the Installation Diagram and Vehicle Wire Reference Chart.

Please note that Maestro RR will only retain functionalities that were originally available in the vehicle.

NEED HELP?

 **1 866 427-2999**

 support@idatalink.com

 maestro.idatalink.com/support
www.12voltdata.com/forum

DURING INSTALLATION

Installation Instructions	3
Wiring Diagram	4
Radio Wire Reference Chart	5

INSTALLATION INSTRUCTIONS

STEP 1

- Unbox the aftermarket radio and locate its main harness.
- Connect the wires shown on the next page from aftermarket radio main harness to the T02 T-harness and match the wire functions.
- Remove the factory radio.

STEP 2

- If the vehicle is equipped with an OEM backup camera: Cut the reverse camera plug of the T02 T-harness and connect the wires as indicated in the wiring diagram next page (BROWN/RED and BROWN/YELLOW wires are not used).

STEP 3

- Connect the factory harness to the T02 T-harness.

STEP 4

- Plug the male WHITE 2 pin connector of your T02 T-harness into the OBDII harness.
- Plug the OBDII connector into the OBDII of the vehicle.

STEP 5

- Plug the aftermarket radio harnesses into the aftermarket radio.
- Connect the backup camera RCA cable into the aftermarket radio (if equipped).
- Connect the auxiliary RCA cables into the aftermarket radio (if equipped).
- Plug the Data cable to the data port of the aftermarket radio.

STEP 6

- Connect all the harnesses to the Maestro RR module then test your installation.

TROUBLESHOOTING TIPS:

- To reset the module back its factory settings, turn the key to the OFF position then disconnect all connectors from the module. Press and hold the module's programming button and connect all the connectors back to the module. Wait, the module's LED will flash RED rapidly (this may take up to 10 seconds). Release the programming button. Wait, the LED will turn solid GREEN for 2 seconds.
- For technical assistance call 1-866-427-2999 or e-mail "support@idatalink.com". Visit us at "maestro.idatalink.com/support" and "www.12voltdata.com/forum/"

WIRING DIAGRAM *with an Amplifier*

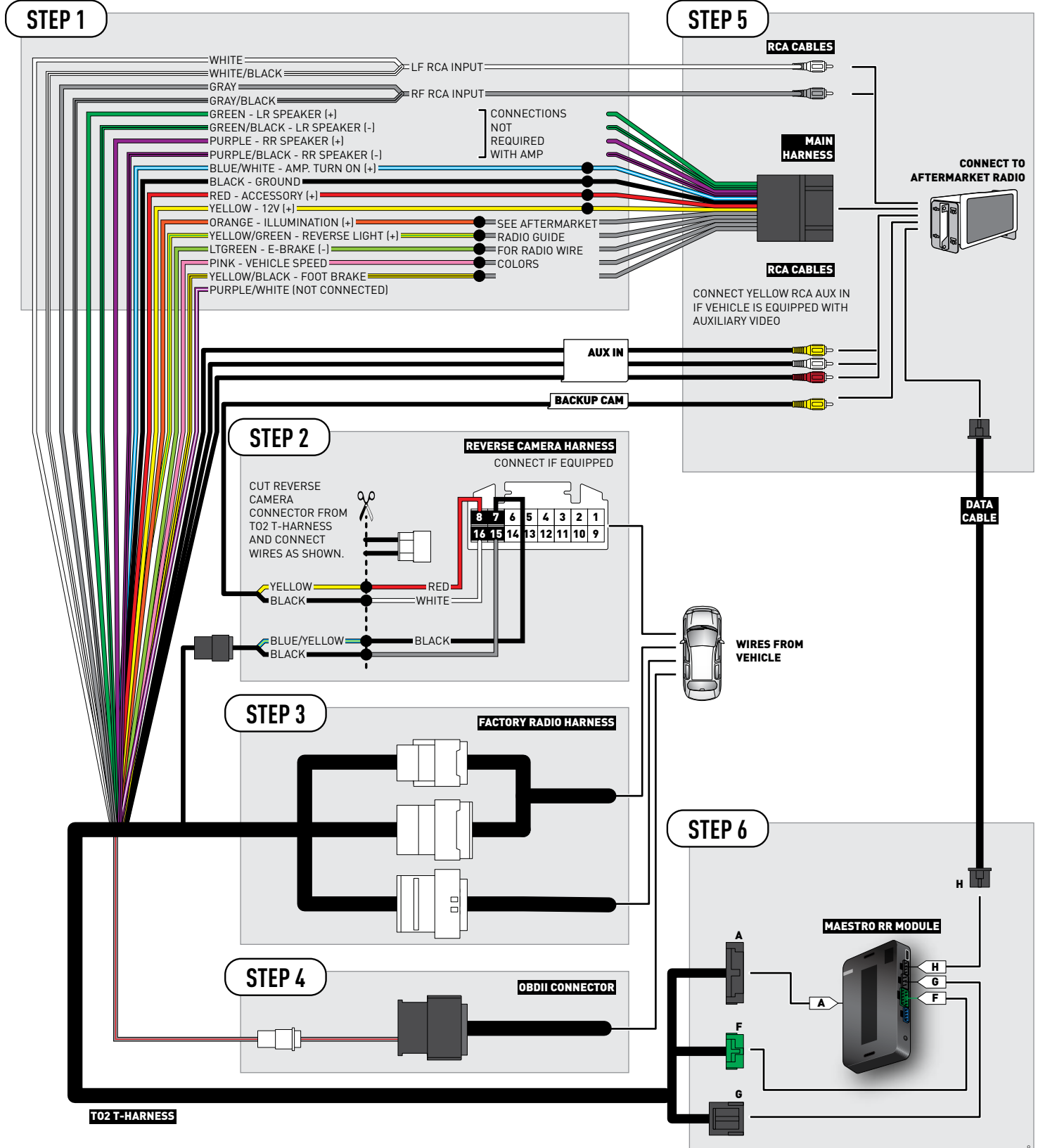

RADIO WIRE REFERENCE CHART

Wire Description	Polarity	Wire Color on Maestro T-Harness	Wire Color on Alpine cable	Wire Color on Kenwood cable	Wire Color on Pioneer cable
Illumination	(+)	Orange	N/A	Orange/White	Orange/White
Reverse Light	(+)	Purple/White or Yellow/Green (see Wiring diagram)	Orange/White	Purple/White	Purple/White
E-Brake	(-)	Lt Green	Yellow/Blue	Lt Green	Lt Green
Foot Brake	(+)	Yellow/Black	Yellow/Black	N/A	N/A
VSS (vehicle speed sensor)	(DATA)	Pink	Green/White	N/A	Pink



INSTALL GUIDE TOYOTA VENZA WITHOUT JBL 2015-2016

RETAINS FACTORY AMPLIFIER, STEERING WHEEL CONTROLS, AND MORE!



PRODUCTS REQUIRED

iDatalink Maestro RR Radio Replacement Interface
iDatalink Maestro T02 Installation Harness

OPTIONAL ACCESSORIES

PROGRAMMED FIRMWARE

ADS-RR(SR)-TOY02-DS

NOTICE: Automotive Data Solutions Inc. (ADS) recommends having this installation performed by a certified technician. Logos and trademarks used here in are the properties of their respective owners.

WELCOME

Congratulations on the purchase of your iDatalink Maestro RR Radio replacement solution. You are now a few simple steps away from enjoying your new car radio with enhanced features.

Before starting your installation, please ensure that your iDatalink Maestro module is programmed with the correct firmware and that you carefully review the Installation Diagram and Vehicle Wire Reference Chart.

Please note that Maestro RR will only retain functionalities that were originally available in the vehicle.

NEED HELP?

 **1 866 427-2999**

 **support@idatalink.com**

 **maestro.idatalink.com/support
www.12voltdata.com/forum**

DURING INSTALLATION

Installation Instructions	3
Wiring Diagram	4
Radio Wire Reference Chart	5

INSTALLATION INSTRUCTIONS

STEP 1

- Unbox the aftermarket radio and locate its main harness.
- Cut and remove the front speaker wire junction connectors.
- Connect the wires shown on the next page from aftermarket radio main harness to the T02 T-harness and match the wire functions.
- Remove the factory radio.

STEP 2

- If the vehicle is equipped with an OEM backup camera, connect the T02 T-harness to the backup camera harness.

STEP 3

- Connect the factory harness to the T02 T-harness.

STEP 4

- Plug the male WHITE 2 pin connector of your T02 T-harness into the OBDII harness.
- Plug the OBDII connector into the OBDII of the vehicle.

STEP 5

- Plug the aftermarket radio harnesses into the aftermarket radio.
- Connect the backup camera RCA cable into the aftermarket radio (if equipped).
- Connect the auxiliary RCA cables into the aftermarket radio (if equipped).
- Plug the Data cable to the data port of the aftermarket radio.

STEP 6

- Connect all the harnesses to the Maestro RR module then test your installation.

TROUBLESHOOTING TIPS:

- To reset the module back its factory settings, turn the key to the OFF position then disconnect all connectors from the module. Press and hold the module's programming button and connect all the connectors back to the module. Wait, the module's LED will flash RED rapidly (this may take up to 10 seconds). Release the programming button. Wait, the LED will turn solid GREEN for 2 seconds.
- For technical assistance call 1-866-427-2999 or e-mail "support@idatalink.com". Visit us at "maestro.idatalink.com/support" and "www.12voltdata.com/forum/"

WIRING DIAGRAM *without an Amplifier*

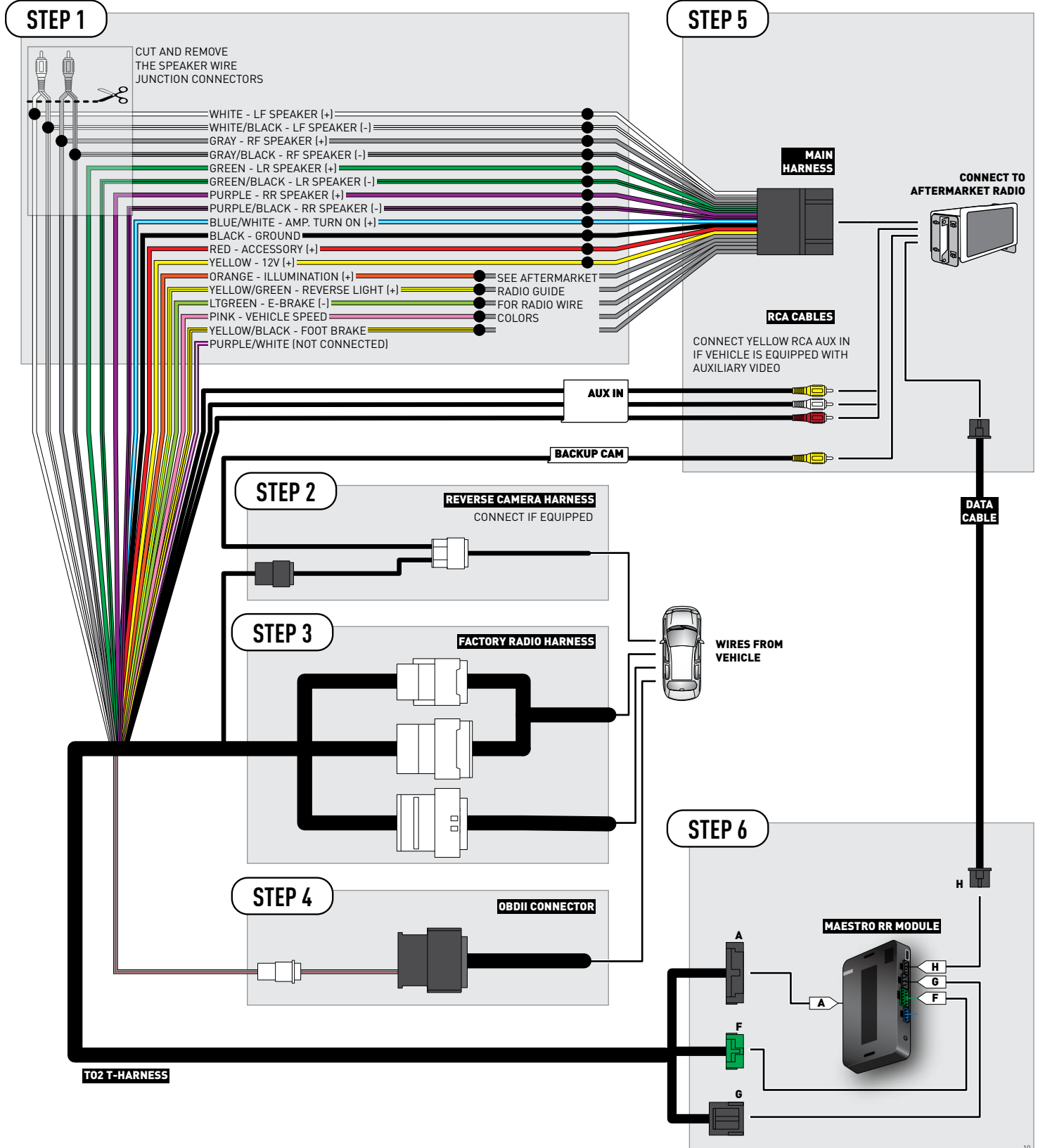

RADIO WIRE REFERENCE CHART

Wire Description	Polarity	Wire Color on Maestro T-Harness	Wire Color on Alpine cable	Wire Color on Kenwood cable	Wire Color on Pioneer cable
Illumination	(+)	Orange	N/A	Orange/White	Orange/White
Reverse Light	(+)	Purple/White or Yellow/Green (see Wiring diagram)	Orange/White	Purple/White	Purple/White
E-Brake	(-)	Lt Green	Yellow/Blue	Lt Green	Lt Green
Foot Brake	(+)	Yellow/Black	Yellow/Black	N/A	N/A
VSS (vehicle speed sensor)	(DATA)	Pink	Green/White	N/A	Pink